

**TOSHIBA**

FILE NO. 030-200002

SERVICE MANUAL

# COLOUR TELEVISION

C00S Chassis

***32ZD08G***

***32ZD08B***

# TABLE OF CONTENTS

## CHAPTER 1 GENERAL ADJUSTMENTS

SAFETY INSTRUCTIONS .....	3
SET-UP ADJUSTMENT .....	4
SERVICE MODE .....	6
DESIGN MODE .....	9
ELECTRICAL ADJUSTMENTS .....	10
CIRCUIT CHECK.....	17

## CHAPTER 2 SPECIFIC INFORMATIONS

SETTING & ADJUSTING DATA .....	18
LOCATION OF CONTROLS .....	19
CIRCUIT BLOCK DIAGRAM .....	21
CHASSIS AND CABINET REPLACEMENT PARTS LIST .....	22
PC BOARDS BOTTOM VIEW.....	43
TERMINAL VIEW OF TRANSISTORS .....	54
SPECIFICATIONS .....	55

### APPENDIX:

CIRCUIT DIAGRAM

### SAFETY INSTRUCTIONS

**WARNING:** BEFORE SERVICING THIS CHASSIS, READ THE “X-RAY RADIATION PRECAUTION”, “SAFETY PRECAUTION” AND “PRODUCT SAFETY NOTICE” INSTRUCTIONS BELOW.

#### X-RAY RADIATION PRECAUTION

1. Excessive high voltage can produce potentially hazardous X-RAY RADIATION. To avoid such hazards, the high voltage must not be above the specified limit. The nominal value of the high voltage of this receiver is (A) kV at zero beam current (minimum brightness) under a (C) V AC power source. The high voltage must not, under any circumstances, exceed (B) kV.
2. The only source of X-RAY RADIATION in this TV receiver is the picture tube. For continued X-RAY RADIATION protection, the replacement tube must be exactly the same type tube as specified in the parts list.
3. Some part in this receiver have special safety-related characteristics for X-RAY RADIATION protection. For continued safety, parts replacement should be undertaken only after referring to the PRODUCT SAFETY NOTICE below.

Refer to table-1 for high voltage (A), (B) & AC voltage (C).  
(See SETTING & ADJUSTING DATA on page 18)

Each time a receiver requires servicing, the high voltage should be checked following the HIGH VOLTAGE CHECK procedure in this manual. It is recommended that the reading of the high voltage be recorded as a part of the service record. It is important to use an accurate and reliable high voltage meter.

#### SAFETY PRECAUTION

**WARNING :** Service should not be attempted by anyone unfamiliar with the necessary precautions on this receiver. The following are the necessary precautions to be observed before servicing this chassis.

1. An isolation transformer should be connected in the power line between the receiver and the AC line before any service is performed on the receiver.
2. Always discharge the picture tube anode to the CRT conductive coating before handling the picture tube. The picture tube is highly evacuated and if broken, glass fragments will be violently expelled. Use shatter proof goggles and keep picture tube away from the unprotected body while handling.
3. When replacing a chassis in the cabinet, always be certain that all the protective devices are put back in place, such as; non-metallic control knobs, insulating covers, shields, isolation resistor-capacitor network etc.

#### PRODUCT SAFETY NOTICE

Many electrical and mechanical parts in this chassis have special safety-related characteristics. These characteristics are often passed unnoticed by a visual inspection and the protection afforded by them cannot necessarily be obtained by using replacement components rated for higher voltage, wattage, etc. Replacement parts which have these special safety characteristics are identified in this manual and its supplements; electrical components having such features are identified by the international hazard symbols on the schematic diagram and the parts list.

Before replacing any of these components, read the parts list in this manual carefully. The use of substitute replacement parts which do not have the same safety characteristics as specified in the parts list may create shock, fire, X-ray radiation or other hazards.

**WARNING:** BEFORE SERVICING THIS CHASSIS, READ THE "X-RAY RADIATION PRECAUTION", "SAFETY PRECAUTION" AND "PRODUCT SAFETY NOTICE" ON PAGE 3 OF THIS MANUAL.

## SET-UP ADJUSTMENT

■ The following adjustments should be made when a complete realignment is required or a new picture tube is installed. Perform the adjustments in order as follows :

1. Color Purity
2. Convergence
3. White Balance

Note: The PURITY/CONVERGENCE MAGNET assembly and rubber wedges need mechanical positioning. Refer to figure 1.

Mounting position of the purity magnet assembly should fit to same position as old one because slightly difference to the position depend on a kind of tube.

\* There are no adjustment of purity and convergence in some picture tube (Unified with purity magnet)

### COLOR PURITY ADJUSTMENT

NOTE : Before attempting any purity adjustments, the receiver should be operated for at least fifteen minutes.

1. Demagnetize the picture tube and cabinet using a degaussing coil.
2. Set the brightness and contrast to maximum.
3. Use a green raster from among the built-in test signals.
4. Loosen the clamp screw holding the yoke and slide the yoke backward or forward to provide vertical green belt (zone) in the picture screen.
5. Remove the Rubber Wedges.
6. Rotate and spread the tabs of the purity magnet (See figure 2.) around the neck of the picture tube until the green belt is in the center of the screen. At the same time, enter the raster vertically.
7. Slowly move the yoke forward or backward until a uniform green screen is obtained. Tighten the clamp screw of the yoke temporarily.
8. Check the purity of the red and blue raster.

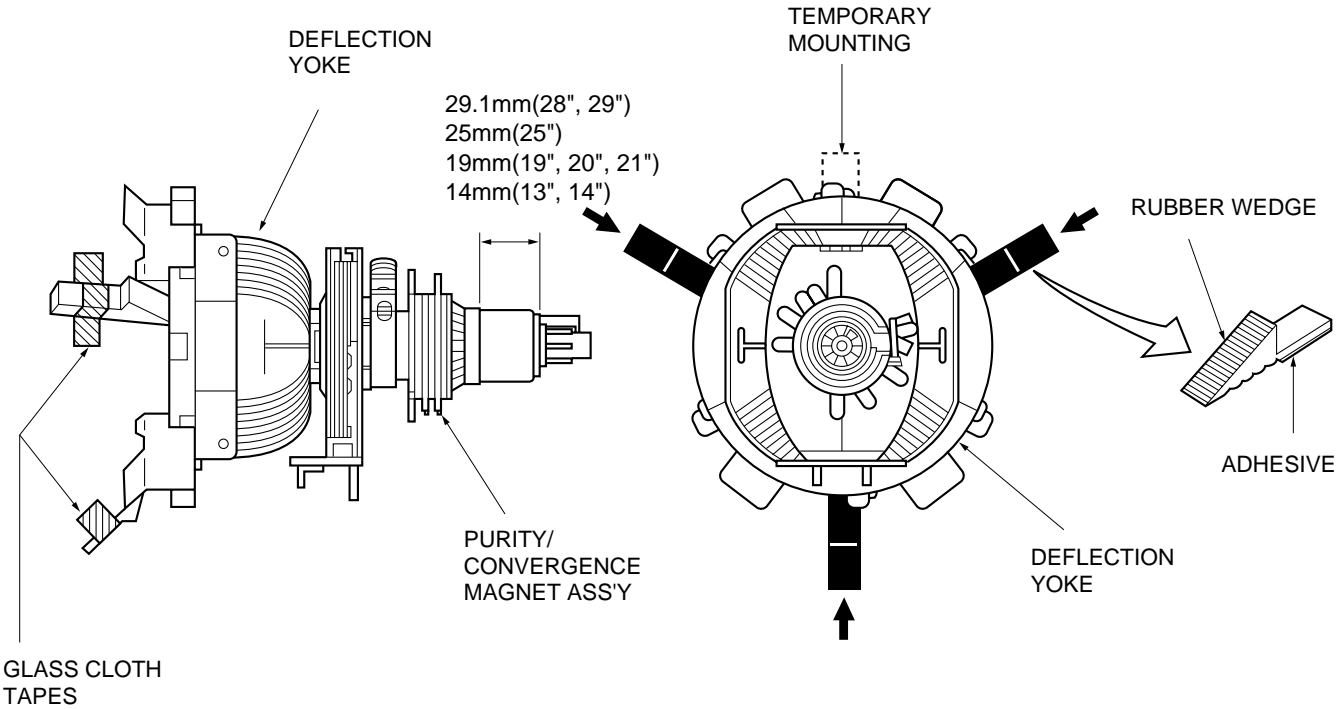

Figure 1.

### CONVERGENCE ADJUSTMENTS

NOTE: Before attempting any convergence adjustments, the receiver should be operated for at least fifteen minutes.

#### ■ CENTER CONVERGENCE ADJUSTMENT

1. Use the cross-dot pattern from among the built-in test signals.
2. Set the brightness and contrast for well defined pattern.
3. Adjust two tabs of the 4-Pole Magnets to change the angle between them (See figure 2.) and superimpose red and blue vertical lines in the center area of the picture screen.
4. Turn the both tabs at the same time keeping the angle constant to superimpose red and blue horizontal lines at the center of the screen.
5. Adjust two tabs of 6-Pole Magnets to superimpose red/blue line and green one. Adjusting the angle affects the vertical lines and rotating both magnets affects the horizontal lines.
6. Repeat adjustments 3, 4, 5 keeping in mind red, green and blue movement, because 4-Pole Magnets and 6-Pole Magnets have mutual interaction and make dot movement complex.

#### ■ CIRCUMFERENCE CONVERGENCE ADJUSTMENT

1. Loosen the clamping screw of deflection yoke slightly to allow the yoke to tilt.
2. Temporarily put a wedge as shown in figure 1. (Do not remove cover paper on adhesive part of the wedge.)
3. Tilt front of the deflection yoke up or down to obtain better convergence in circumference. (See figure 3.) Push the mounted wedge into the space between picture tube and the yoke to fix the yoke temporarily.
4. Put other wedge into bottom space and remove the cover paper to stick.
5. Tilt front of the yoke right or left to obtain better convergence in circumference. (See figure 3.)
6. Keep the yoke position and put another wedge in either upper space. Remove cover paper and stick the wedge on picture tube to fix the yoke.
7. Detach the temporarily mounted wedge and put it in another upper space. Stick it on picture tube to fix the yoke.
8. After fixing three wedges, recheck overall convergence. Tighten the screw firmly to fix the yoke and check the yoke is firm.
9. Stick three adhesive tapes on wedges as shown in figure 1.

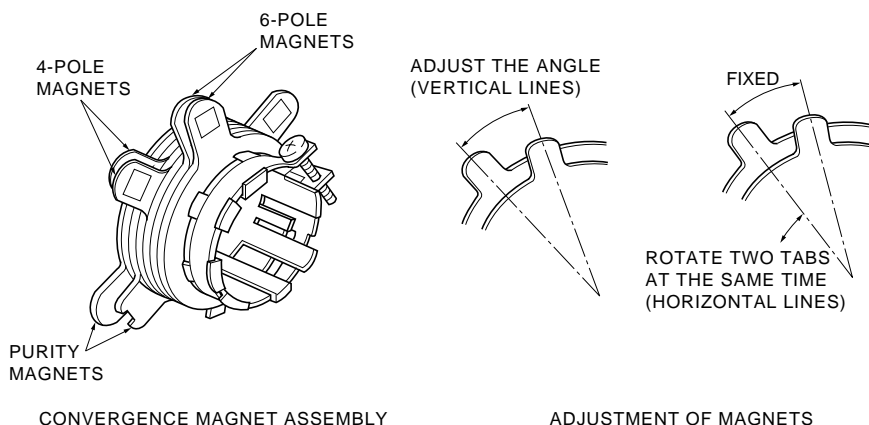
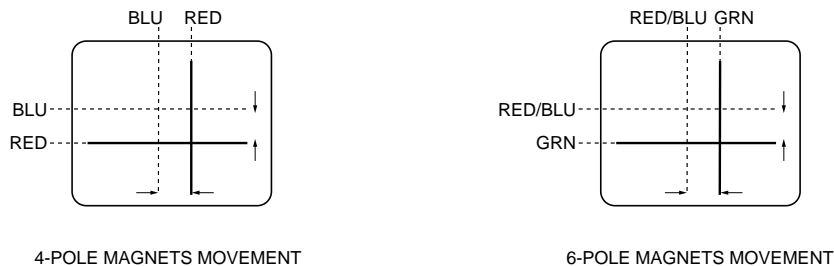

Figure 2.



Center Convergence by Convergence Magnets





Circumference Convergence by DEF Yoke

Figure 3. Dot Movement Pattern

# SERVICE MODE

## 1. ENTERING TO SERVICE MODE

- 1) Press  button once on Remote Control.
- 2) Press  button again to keep pressing.
- 3) While pressing the  button, press MENU button on TV set.

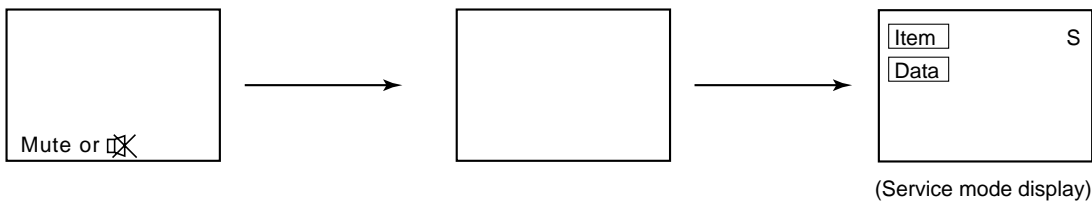

## 2. DISPLAYING THE ADJUSTMENT MENU

- 1) Press MENU button on TV.

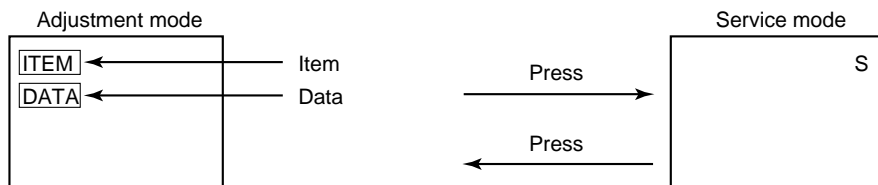

## 3. KEY FUNCTION IN THE SERVICE MODE

The following key entry during display of adjustment menu provides special functions.

A single horizontal line ON/OFF:

Test signal selection :

Selection of the adjustment items :

Change of the data value :

Adjustment menu mode ON/OFF :

Initialization of the memory (QA02) :  
Reset the count of operating protect circuit to "00":

"RCUT" selection :

"GCUT" selection :

"BCUT" selection :

"CNTX" (or "SCNT") selection :

"COLC" selection :

"TNTC" selection :

Self diagnostic display ON/OFF :

INFO button (on Remote) or  button (on TV)

 button (on Remote)

Channel /  (on TV or Remote)

Volume  +/- (on TV or Remote)

MENU button (on TV)

CALL + Channel button on TV (

CALL + Channel button on TV (

1 button

2 button

3 button

4 button

5 button - - - - Color thickness correction

6 button

9 button

note: Displayed differently as shown below, depending on the setting of the receiving color system.

COLP (PAL)

COLC (NTSC)

COLS (SECAM)

CAUTION : Never try to perform initialization unless you have changed the memory IC.

#### 4. SELECTING THE ADJUSTING ITEMS

- 1) Every pressing of CHANNEL ▲ button in the service mode changes the adjustment items in the order of table-2. (▼ button for reverse order)

Refer to table-2 for preset data of adjustment mode.  
(See SETTING & ADJUSTING DATA on page 18)

#### 5. ADJUSTING THE DATA

- 1) Pressing of VOLUME ▲ +/- button will change the value of data in the range from 00H to FFH. The variable range depends on the adjusting item.

#### 6. EXIT FROM SERVICE MODE

- 1) Pressing POWER button to turn off the TV once.

#### ■ INITIALIZATION OF MEMORY DATA OF QA02

After replacing QA02, the following initialization is required.

1. Enter the service mode, then select any register item.
2. Press and hold the CALL button on the Remote, then press the CHANNEL ▲ button on the TV. The initialization of QA02 has been completed.
3. Check the picture carefully. If necessary, adjust any adjustment item above.  
Perform "Auto search Memory" on the owner's manual.

CAUTION: Never attempt to initialize the data unless QA02 has been replaced.

#### 7. TEST SIGNAL SELECTION

- 1) Every pressing of -⊖ button on the Remote Control changes the built-in test patterns on screen as described below in SERVICE MODE.

Signal off —→ NTSC signals (5 patterns)  
 ↑ PAL signals (5 patterns) ←

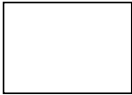
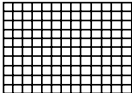
Signals	Picture
<ul style="list-style-type: none"> <li>• Red raster</li> <li>• Green raster</li> <li>• Blue raster</li> <li>• All White</li> </ul>	
<ul style="list-style-type: none"> <li>• Black cross-hatch</li> </ul>	

\* The signals marked with ■ are not usable to display in the Test signal for some model.

### 8. SELF DIAGNOSTIC FUNCTION

- 1) Press "9" button on Remote Control during display of adjustment menu in the service mode.  
The diagnosis will begin to check if interface among IC's are executed properly.
- 2) During diagnosis, the following displays are shown.

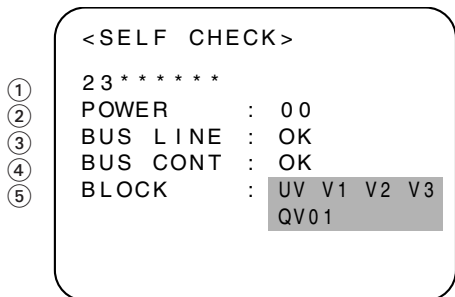

Indicated color of mode now selected : Green and Red  
Indicated color of other modes : White

Green : Normal  
Red : The microcomputer operates to provide judgement of no video signal. The red color is still indicated though the signal is input, failure may exist in input signal line including QV01.  
QV01 : In case of indication green ---Normal  
In case of indication red with input signal---  
Failure may exist in output line including QV01.

- ① Part number of microcomputer (QA01)
- ② Operation number of protecting circuit ----"00" is normal.  
When indication is other than "00", overcurrent appts to flow, and circuit parts may possibly be damaged.
- ③ BUS LINE CHECK ----"OK" is normal.  
"SDA1-GND" ----- SDA-GND short circuit.  
"SCL1-GND" ----- SCL-GND short circuit.  
"SCL1-SDA1" ----- SCL-SDA short circuit.
- ④ BUS CONT ----"OK" is normal.  
When indication shows "Q○○○ NG", the device with the number may possibly be damaged.
- ⑤ BLOCK  
UV : TV reception mode  
V1 : VIDEO 1 input mode (→1)  
V2 : VIDEO 2 input mode (→2)  
V3 : VIDEO 3 input mode (→3)

**NOTE:** Component which controls character display on screen is ICF01 (TELETEXT IC.). If this display function fails to operate due to damage in ICF01, self diagnosis procedure is as follows.

- (1) In case that power indicator is blinking with interval of 0.5 seconds; it means protecting circuit (Current limiter) is operating, and circuit components may possibly be damaged. Check related components.
- (2) In case that power indicator is blinking with interval of 1 second; Protecting circuit does not operate, but a part of Bus line does not operate normally. Check Bus line.

\* The items marked with ■ are not usable to display in the SELF DIAGNOSTIC FUCTION for some model.



# DESIGN MODE

## 1. ENTERING TO DESIGN MODE

- 1) Select the Service mode.
- 2) While pressing  or CALL button on Remote and press MENU button on TV.
- 3) Press MENU button on TV.

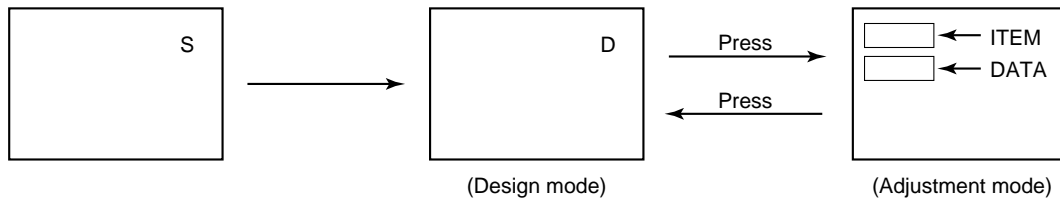

When QA02 is initialized, items "OPT0" and "OPT1" of DESIGN MODE are set to the data of the representative model of this chassis family.

Therefore, because ON-SCREEN specification remains in the state of the representative of model. This model is required to reset the data of items "OPT0" and "OPT1".

## 2. SELECTING THE ADJUSTING ITEMS

Every pressing of CHANNEL ▼ button in the design mode changes the adjustment items in the order of table-3. (▲ button for reverse order)



Refer to table-3 for data of design mode.  
(See SETTING & ADJUSTING DATA on page 18)

## 3. ADJUSTING THE DATA

Pressing of VOLUME ▲ or ▼ button will change the value of data.

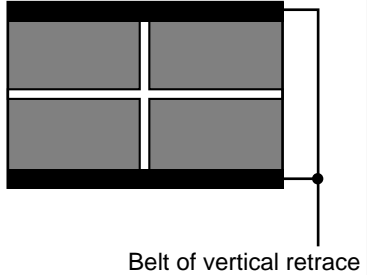
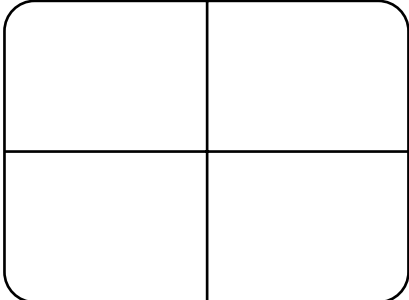
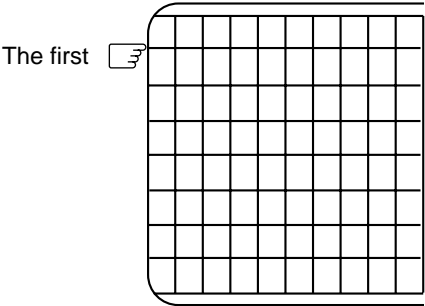
## ELECTRICAL ADJUSTMENTS

ITEM	ADJUSTMENT PROCEDURE
<p>FOCUS VR ADJ</p>	<ol style="list-style-type: none"> <li>1. Enter the service mode, then select any register item.</li> <li>2. Press the TV/VIDEO button on the Remote until the black cross-bar pattern appears on the screen.</li> <li>3. Adjust the FOCUS control (on T461) for well defined scanning lines on the picture screen.</li> </ol>
<p>SUB-BRIGHTNESS (BRTC)</p> <p>Note: Constrict the picture height until the vertical retrace line appears adjusting the item HIT (HEIGHT).</p>	<ol style="list-style-type: none"> <li>1. Set CONTRAST to minimum, and BRIGHTNESS to center by adjusting user controls.</li> <li>2. Set the TV in service mode to get white cross-bar of inside pattern.</li> <li>3. Select BRTC (brightness correction), and adjust the <math>\blacktriangle</math> - <math>\blacktriangledown</math> button to reduce the value so that white portion of inside pattern slightly light.</li> <li>4. Adjust <math>\blacktriangle</math> - <math>\blacktriangledown</math> button to increase the data value of BRTC, and set it just before the difference between the belt of vertical retrace and the border of black portion of inside pattern is visible. After that, return vertical height and contrast.</li> </ol> 
<p>HORIZONTAL POSITION ADJUSTMENT (HPOS)</p> <p>VERTICAL POSITION ADJUSTMENT (VPOS)</p>	<ol style="list-style-type: none"> <li>1. Set the TV in service mode, and get black or white cross-bar signal with VIDEO button on remote hand unit.</li> <li>2. Select either HPOS (Horizontal picture phase) or VPOS (Vertical picture phase) with CHANNEL <math>\blacktriangle</math>, <math>\blacktriangledown</math> buttons, and adjust horizontal or vertical picture position in the center of screen with VOLUME <math>\blacktriangle</math> - <math>\blacktriangledown</math> buttons.</li> </ol> 
<p>VERTICAL AMPLITUDE ADJUSTMENT (HIT)</p>	<ol style="list-style-type: none"> <li>1. Set the TV in service mode, and get black or white cross-hatch signal with VIDEO button on remote hand unit.</li> <li>2. Select HIT (Vertical amplitude) with CHANNEL <math>\blacktriangle</math>, <math>\blacktriangledown</math> buttons, and adjust vertical amplitude with VOLUME <math>\blacktriangle</math> - <math>\blacktriangledown</math> buttons so that vertical amplitude lacks a little.</li> <li>3. Adjust vertical amplitude with VOLUME <math>\blacktriangle</math> - <math>\blacktriangledown</math> buttons so that the first bar on cross-hatch signal touches edge of screen.</li> </ol> 

ITEM	ADJUSTMENT PROCEDURE
<p>WHITE BALANCE ADJUSTMENT</p> <ul style="list-style-type: none"> <li>● CUTOFF ADJUSTMENT (RCUT) (GCUT) (BCUT)</li> <li>● DRIVE ADJUSTMENT (GDRV) (BDRV)</li> </ul>	<ol style="list-style-type: none"> <li>1. Set Contrast to 40, and brightness to +20 by picture control.</li> <li>2. Set the TV in service mode, and get the inside W/B adjusting signal with VIDEO button.</li> <li>3. Select RCUT, GCUT and BCUT with CHANNEL ▲, ▼ buttons, to set individual values to Initial reference data, and to set GDRV and BDRV to Initial reference data with VOLUME ▲ - /+ buttons (See page 18).</li> <li>4. Press  button on the remote control and rotate Screen VR to get one slight horizontal line on screen. Note: Every pressing of  button provides Horizontal line picture and Normal picture alternately.</li> <li>5. Press  button to release horizontal line picture, and select the two other colors which did not light in the above step with CHANNEL ▲, ▼ buttons. Then tap VOLUME ▲ - /+ buttons so that three colors slightly light in the same level.</li> </ol> <ul style="list-style-type: none"> <li>※ To correct white balance in light area, select GDRV and BDRV with CHANNEL ▲, ▼ buttons to adjust.</li> <li>※ To correct white balance in dark area, perform fine adjustment of RCUT, GCUT and BCUT.</li> </ul> <div style="border: 1px solid black; border-radius: 15px; padding: 10px; margin-top: 10px;"> <div style="border: 1px solid black; width: fit-content; margin: 0 auto; padding: 5px; text-align: center;">Light area check (to show white)</div> <div style="text-align: center; margin-top: 20px;">Dark area check (to show black)</div> </div>

(Reference Factory Adjustments)

Items	Names	Settings (User control)	Input signals	Measuring points	Adjusting methods	Adjusting standards
[SCNT]	Sub-contrast	Dynamic MODE Screen size: WIDE Audio system: I	Sub-bright signal (PAL-I Signal)	TP46B	① Adjust the amplitude from the pedestal level to the white peak.	2.5 ± 0.1 Vp-p
[BRTC]	Sub-bright Center	Dynamic MODE Screen size: WIDE	Sub-bright Signal	Screen adjustment	① Adjust the number of collapsed black lines of the sub-bright signal. ② To adjust after W/B, [SCNT] adjustment.	4±1.5 pieces Screen adjustment
[COLP]	Sub-color center PAL	Dynamic MODE Screen size: Dynamic	Sub-bright Signal (PAL)	TP46B	① Adjust the amplitude of B-Y. (Be sure to apply Y mute during adjustment)	1.2 ± 0.1 Vo-p
SCREEN VR [RCUT] [GCUT] [BCUT] [GDRV] [BDRV]	R Cutoff G Cutoff B Cutoff G Drive B Drive	MODE Screen size: WIDE [RCUT]: 40 [GCUT]: 40 [BCUT]: 40 [GDRV]: 40 [BDRV]: 40		Screen adjustment	① Enter Horizontal Straight-line Mode. ② Gradually increase the screen VR until R, G, or B line starts to light up slightly. ③ Determine the screen VR adjustment position here. ④ Gradually increase remaining two screen VRs – except the line that lit up as mentioned in item ② above – until respective line starts to light up slightly. (Adjust until the screen becomes almost white.) ⑤ Exit from Horizontal Straight-line Mode. ⑥ Using CA100, repeat this adjustment until correct value is set to both the dark and bright parts.	Bright part (103cd/m <sup>2</sup> ) 8750K-0.002uv Dark part (17cd/m <sup>2</sup> ) 8750K-0.002uv  Screen judgment (CA100)

Items	Names	Settings (User control)	Input signals	Measuring points	Adjusting methods	Adjusting standards
[SBY]	SECAM B-Y Black level		SECAM Color bar	TP01	① Vary [SBY] so that the level of mono- chrome signal part aligns with that of BLK.	0 ± 10 mV
[SRY]	SECAM R-Y Black level		SECAM Color bar	TP02	① Vary [SRY] so that the level of mono- chrome signal part aligns with that of BLK.	0 ± 10 mV
[COLS]	Sub-color Center SECAM	Dynamic MODE Screen size: WIDE	SECAM Color bar	TP46B	① Adjust the amplitude of B-Y. (Be sure to apply Y mute during adjust- ment)	1.6 ± 0.1 Vo-p (Pedestal to Peak)

1. Data adjustment

	Adjusting items	Adjusting methods
Vertical	<p>WIDE mode Vertical amplitude [HIT]</p> <p>Vertical position [VPS1]</p>	
Super-live mode Vertical amplitude [HIT]	<p>PAL Phillips Pattern, User adjustment standard Adjust the vertical amplitude by [HIT] so that the top and bottom of the circle will touch the CPT mask with Philips Pattern (see the right sketch).</p>	
CINEMA mode Vertical amplitude [HIT]	<p>Phillips Pattern, User adjustment standard Adjust the vertical amplitude by [HIT] so that the points shown in the right bottom sketch will touch the CRT mask (see the right sketch).</p>	

2. Circuit adjustment (Volume/data adjustment)

No.	Target model names	Adjusting items	Adjusting methods
1	All models	Focus adjustment (1) HOR.FOCUS	<p>Conditions: PAL Retoma signal WIDE mode, User adjustment standard</p> <p>Adjustment: Set it at the position, where the screen center becomes optimum focus and most counterclockwise, using the focus volume (F1) of the fly-back transformer (T461).</p>
		Focus adjustment (2) VERT.FOCUS	<p>Conditions: PAL Retoma signal WIDE mode, User adjustment standard</p> <p>Adjustment: Set it at the position, where the screen center becomes optimum focus and most counterclockwise, using the focus volume (F2) of the fly-back transformer (T461).</p>
2	All models	Vertical position adjustment	<p>Conditions: PAL WG Phillips Pattern WIDE mode, User adjustment standard</p> <p>Adjustment: Use [VPS1] and make adjustments so that the upper and lower positions will touch the mask. (Adjust and orient CPT either toward the south or north. If this is impossible, offset the difference.)</p>

3. Data Adjustment

	Adjustment items	Adjustment methods
Horizontal	<p>WIDE mode (During 4:3)</p> <p>Horizontal phase: [HPOS] Horizontal amplitude: [WIDE] Side DPC: [PARA] Trapezoidal distortion: [TRAP] Corner distortion: [CNR] Center warp: [CPAR] Parallelogram distortion: [CSAW]</p>	<p>Use PAL WG Phillips Pattern and adjust the horizontal amplitude to fit the mask to the frames of left and right flags in WIDE mode.</p> <p>Use PAL WG Phillips Pattern and adjust so that the side-pin and trapezoidal distortions become optimum in WIDE mode. Use the horizontal phase [HPOS] for the horizontal screen position, and make adjustments so that the position will become a center.</p> <p>Check and confirm the side-pin at the mode of 4:3. (If necessary, examine the grade of side panel at the mode of 4:3 and reconfirm)</p> <ul style="list-style-type: none"> <li>• <b>Note:</b> In case distortion adjustment is insufficient by the [PARA] [TRAP] adjustments, make adjustments by using the data of [CNR], [CPAR], and [CSAW].</li> </ul> <ol style="list-style-type: none"> <li>① Decrease [CPAR] in case of the distortion shown in Fig. (a). On the contrary, increase [CPAR] in case of the distortion shown in Fig. (b).</li> <li>② Decrease [CSAW] in case of the distortion shown in Fig. (c). On the contrary, increase [CSAW] in case of the distortion shown in Fig. (d).</li> </ol>
Super-live mode	<p>Horizontal amplitude: [WIDE] Side DPC: [PARA] Trapezoidal distortion: [TRAP] Horizontal phase [HPOS] Corner distortion: [CNR]</p>	<p>Use PAL Phillips Pattern and fit the frames of the left and right flags to the mask in Super-live and WIDE modes.</p> <p>Make adjustments to achieve optimum side-pin distortion and trapezoidal distortion. If any further adjustment is required, use the horizontal phase [HPOS] and corner distortion [CNR] for adjustment.</p>
CINEMA mode	<p>Horizontal amplitude: [WIDE] Side DPC: [PARA] Trapezoidal distortion: [TRAP] Horizontal phase: [HPOS] Corner distortion: [CNR]</p>	<p>Use PAL Phillips Pattern and adjust the horizontal amplitude to fit the mask to the frames of left and right flags in CINEMA mode.</p> <p>Make adjustments to achieve optimum side-pin distortion and trapezoidal distortion. If any further adjustment is required, use the horizontal phase [HPOS] and corner distortion [CNR] for adjustment.</p>



## CIRCUIT CHECK

### HIGH VOLTAGE CHECK

**CAUTION:** There is no HIGH VOLTAGE ADJUSTMENT on this chassis. Checking should be done following the steps below.

1. Connect an accurate high voltage meter to the second anode of the picture tube.
2. Turn on the receiver. Set the BRIGHTNESS and CONTRAST controls to minimum (zero beam current).
3. High voltage must be measured below (B) kV.

Refer to table-1 for high voltage (B).  
(See SETTING & ADJUSTING DATA on page 18)

4. Vary the BRIGHTNESS control to both extremes to be sure the high voltage does not exceed the limit under any conditions.

## CHAPTER 2 SPECIFIC INFORMATIONS

### SETTING & ADJUSTING DATA

#### 【 SAFETY INSTRUCTIONS 】

		32"
HIGH VOLTAGE AT ZERO BEAM:	(A)	33.2 kV
MAX HIGH VOLTAGE:	(B)	34.0 kV
AV VOLTAGE	(C)	220~240 V

Table-1

#### 【 SERVICE MODE 】

##### ADJUSTING ITEMS AND DATAS IN THE SERVICE MODE:

Item	Adjustment	Reference data	Item	Adjustment	Reference data
RCUT	R CUTOFF (B/W)	40H	SRY	SECAM R-Y	08H
GCUT	G CUTOFF (B/W)	40H	SBY	SECAM B-Y	08H
BCUT	B CUTOFF (B/W)	40H	HPOS	50Hz H-POSITION	67H
GDRV	R DRIVE	35H	VPOS	V-POSITION	00H
BDRV	B DRIVE	35H	HIT	HEIGHT	38H
CNTX	SUB CONTRAST MAX	7FH	VLIN	V-LINEARITY	12H
BRTC	SUB BRIGHT CEN	80H	VSC	V-S CORRECTION	23H
COLC	SUB COLOR CEN NTSC	00H	VPS2	V-SHIFT	40H
TNTC	SUB TINT CEN	20H	WID	PICTURE WIDTH	2CH
COLP	SUB COLOR CEN PAL	3DH	PARA	E-W PARABOLA	1CH
COLS	SUB COLOR CEN SECAM	3DH	CNR	E-W CORNER	10H
COLD	SUB COLOR CEN DTV	3DH	TRAP	TRAPEZIUM	4BH
SCNT	SUB CONTRAST	08H	VFC	V-F CORRECTION	0FH

Table-2

#### 【 DESIGN MODE 】

##### ADJUSTING ITEMS AND DATAS IN THE DESIGN MODE:

Item	Name of adjustment	Preset Data	Data	Remarks
* There are no adjusting item in the DESIGN MODE.				

Table-3

# LOCATION OF CONTROLS

Front

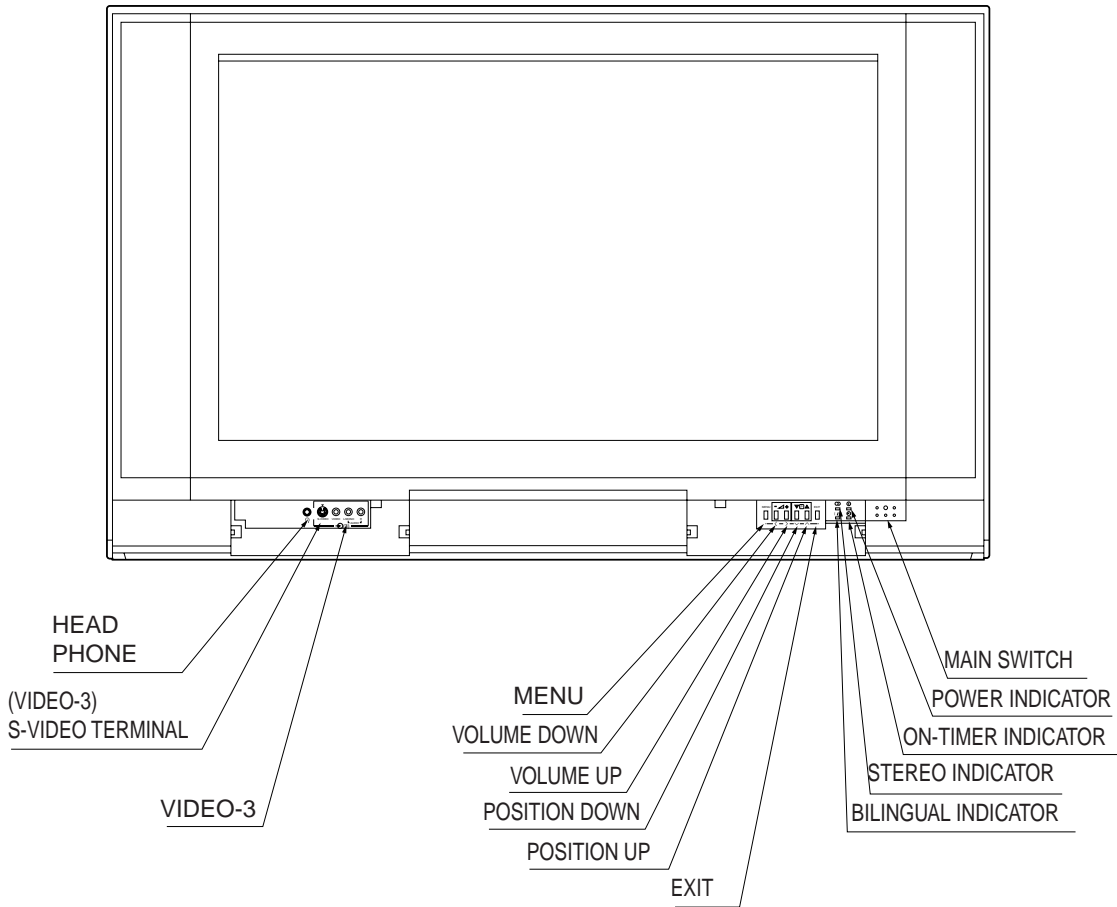

Rear terminals

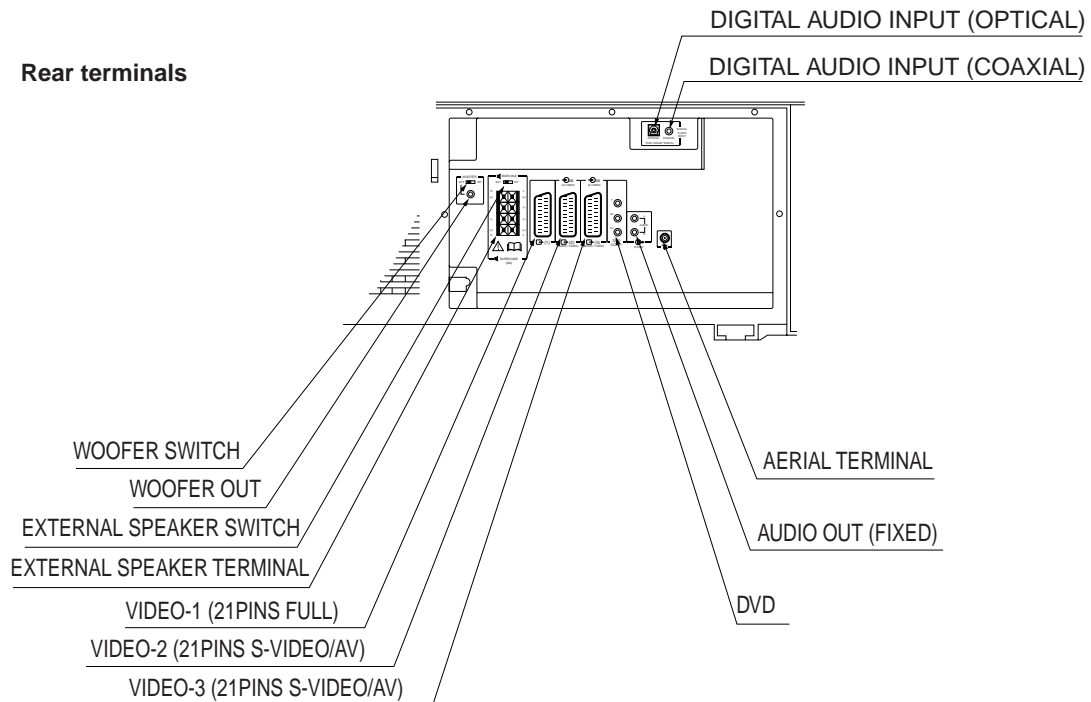

# Remote Controller

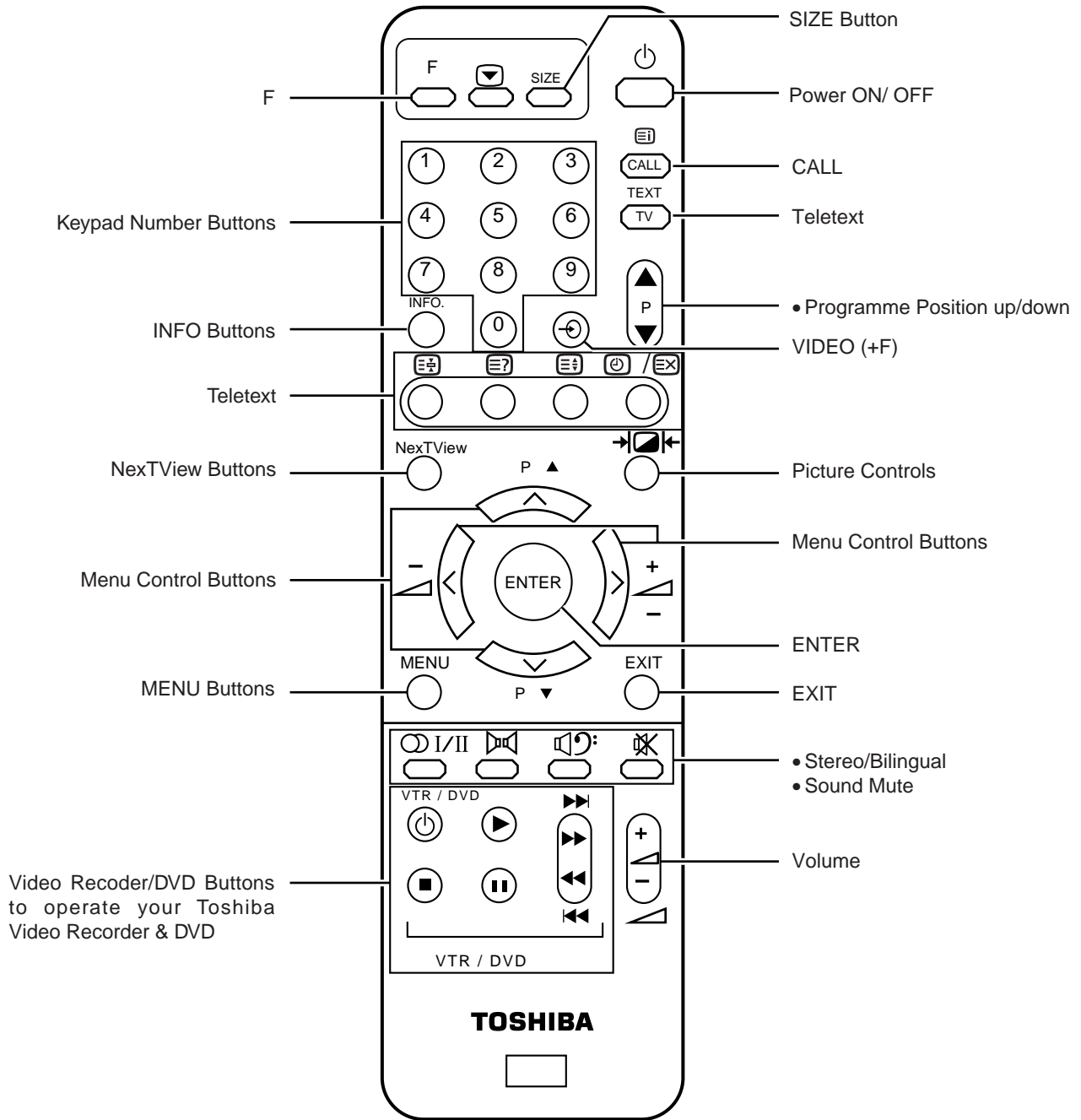

# CIRCUIT BLOCK DIAGRAM

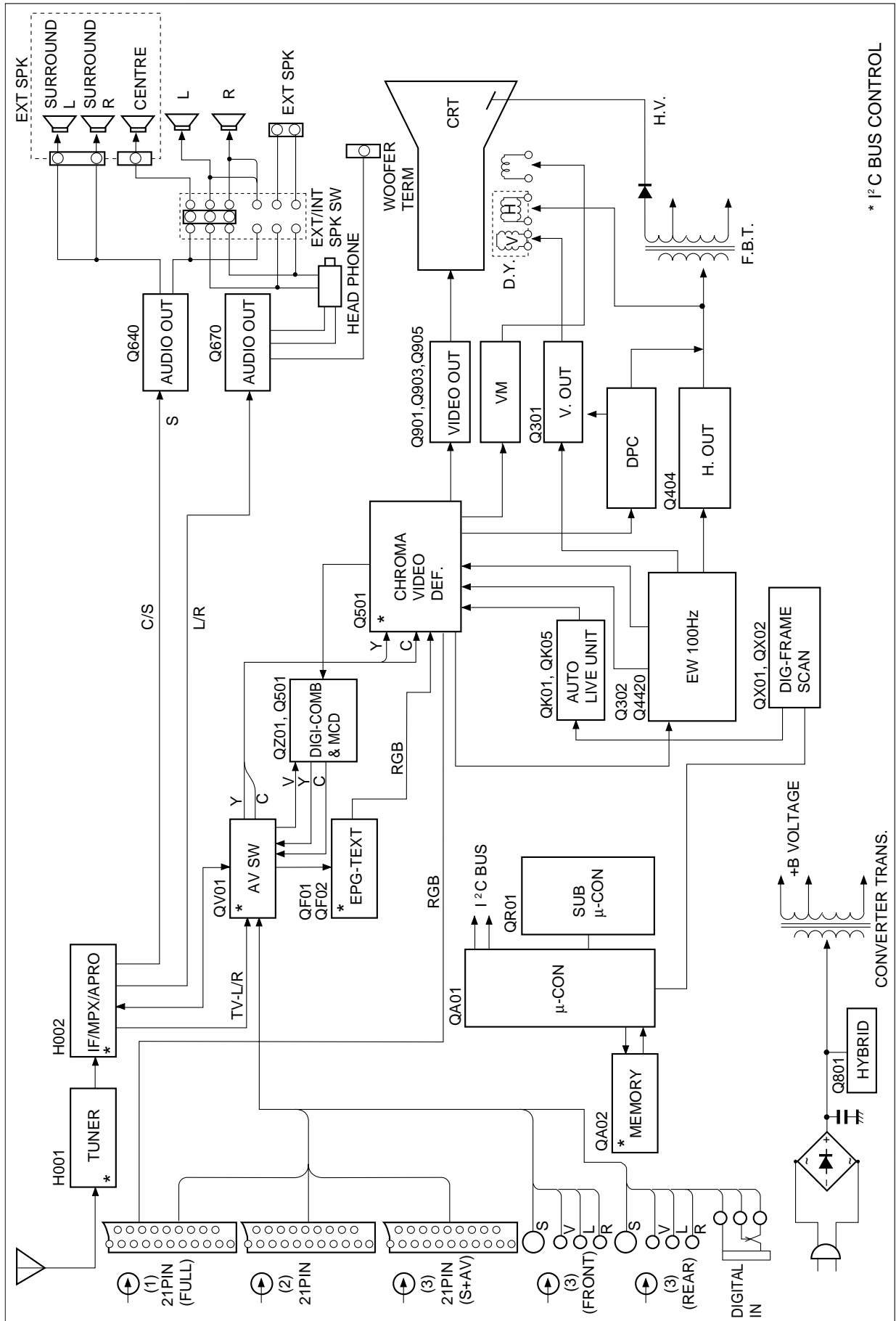

\* I²C BUS CONTROL

# CHASSIS AND CABINET REPLACEMENT PARTS LIST

**WARNING:** BEFORE SERVICING THIS CHASSIS, READ THE "X-RAY RADIATION PRECAUTION", "SAFETY PRECAUTION" AND "PRODUCT SAFETY NOTICE" ON PAGE 3 OF THIS MANUAL.

**CAUTION:** The international hazard symbols "⚠" in the schematic diagram and the parts list designate components which have special characteristics important for safety and should be replaced only with types identical to those in the original circuit or specified in the parts list. The mounting position of replacements is to be identical with originals. Before replacing any of these components, read carefully the PRODUCT SAFETY NOTICE. Do not degrade the safety of the receiver through improper servicing.

**NOTICE:**

- The part number must be used when ordering parts, in order to assist in processing, be sure to include the Model number and Description.
- The PC board assembly with \* mark is no longer available after the end of the production.

**Models : 32ZD08G, 32ZD08B**

Capacitors .....	CD : Ceramic Disk	PF : Plastic Film	EL : Electrolytic
Resistors .....	CF : Carbon Film	CC : Carbon Composition	MF : Metal Film
	OMF : Oxide Metal Film	VR : Variable Resistor	FR : Fusible Resistor

(All CD and PF capacitors are ±5%, 50V and all resistors, ±5%, 1/6W unless otherwise noted.)

SPECIFIC INFORMATIONS

Location No.	Part No.	Description
<b>CAPACITORS</b>		
C102	24763221	EL, 220µF, ±20%, 16V
C105	24212102	CD, 1000pF, ±10%
C106	24797100	EL, 10µF, ±20%, 50V
C108	24794221	EL, 220µF, ±20%, 16V
C109	24232103	CD, 0.01µF, +80%, -20%
C110	24797479	EL, 4.7µF, ±20%, 50V (32ZD08G)
C110	24797229	EL, 2.2µF, ±20%, 50V (32ZD08B)
C111	24797220	EL, 22µF, ±20%, 50V (32ZD08G)
C111	24797229	EL, 2.2µF, ±20%, 50V (32ZD08B)
C115	24232103	CD, 0.01µF, +80%, -20%
C201	24567104	PF, 0.1µF
C202	24232103	CD, 0.01µF, +80%, -20%
C203	24567104	PF, 0.1µF
C204	24797010	EL, 1µF, ±20%, 50V
C205	24797229	EL, 2.2µF, ±20%, 50V
C206	24797220	EL, 22µF, ±20%, 50V
C214	24567334	PF, 0.33µF
C215	24436101	CD, 100pF
C219	24436100	CD, 10pF
C220	24436100	CD, 10pF
C221	24436100	CD, 10pF
C229	24092398	CD, 0.1µF, +80%, -20%, 25V
C230	24232103	CD, 0.01µF, +80%, -20%
C232	24092398	CD, 0.1µF, +80%, -20%, 25V
C261	24794101	EL, 100µF, ±20%, 16V
C262	24232103	CD, 0.01µF, +80%, -20%
C263	24794470	EL, 47µF, ±20%, 16V
C264	24794100	EL, 10µF, ±20%, 16V
C302	24214471	CD, 470pF, ±10%, 500V
C303	24214471	CD, 470pF, ±10%, 500V
C305	24795222	EL, 2200µF, ±20%, 25V
C308	24797221	EL, 220µF, ±20%, 50V
C310	24795222	EL, 2200µF, ±20%, 25V
C313	24082057	PF, 0.22µF, 100V
C314	24793101	EL, 100µF, ±20%, 10V
C315	24212222	CD, 2200pF, ±10%

Location No.	Part No.	Description
C315	24797478	EL, 0.47µF, ±20%, 50V
C316	24795221	EL, 220µF, ±20%, 25V
C318	24794471	EL, 470µF, ±20%, 16V
C320	24795221	EL, 220µF, ±20%, 25V
C321	24567224	PF, 0.22µF
C322	24617915	EL, 1µF, ±10%, 50V
C323	24567474	PF, 0.47µF
C325	24590223	PF, 0.022µF
C326	24797010	EL, 1µF, ±20%, 50V
C327	24794471	EL, 470µF, ±20%, 16V
C329	24567224	PF, 0.22µF
C332	24212102	CD, 1000pF, ±10%
C341	24567474	PF, 0.47µF
C366	24082049	PF, 0.047µF, 100V
C370	24794100	EL, 10µF, ±20%, 16V
C371	24797100	EL, 10µF, ±20%, 50V
C372	24797470	EL, 47µF, ±20%, 50V
C373	24797470	EL, 47µF, ±20%, 50V
C390	24567474	PF, 0.47µF
C391	24567474	PF, 0.47µF
C392	24567474	PF, 0.47µF
C393	24567474	PF, 0.47µF
C401	24232103	CD, 0.01µF, +80%, -20%
C403	24590223	PF, 0.022µF
C404	24797229	EL, 2.2µF, ±20%, 50V
C410	24092341	CD, 470pF, ±10%, 2kV
C413	24214332	CD, 3300pF, ±10%, 500V
C416	24668101	EL, 100µF, ±20%, 35V
C417	24214391	CD, 390pF, ±10%, 500V
C419	24212102	CD, 1000pF, ±10%
C420	24794101	EL, 100µF, ±20%, 16V
C421	24567104	PF, 0.1µF
C423	24829623	PF, 0.063µF, 400V
C424	24794101	EL, 100µF, ±20%, 16V
C425	24794101	EL, 100µF, ±20%, 16V
C430	24232103	CD, 0.01µF, +80%, -20%
C430	24820392	PF, 0.0036µF, 630V
C431	24232103	CD, 0.01µF, +80%, -20%
C431	24794101	EL, 100µF, ±20%, 16V
C440	24082941	PF, 3000pF, ±3%, 1500V
C442	24082639	PF, 0.12µF, 400V

Location No.	Part No.	Description
C443	24082638	PF, 0.11 $\mu$ F, 400V
C444	24082830	PF, 3000pF, $\pm$ 3%, 1800V
C445	24828473	PF, 0.047 $\mu$ F, 200V
C446	24679330	EL, 33 $\mu$ F, $\pm$ 20%, 250V
C447	24829183	PF, 0.018 $\mu$ F, 400V
C448	24640908	EL, 33 $\mu$ F, $\pm$ 20%, 160V
C461	24082834	PF, 4300pF, $\pm$ 3%, 1800V
C462	24794222	EL, 2200 $\mu$ F, $\pm$ 20%, 16V
C463	24212392	CD, 3900pF, $\pm$ 10%
C464	24640872	EL, 10 $\mu$ F, $\pm$ 20%, 100V
C470	24794470	EL, 47 $\mu$ F, $\pm$ 20%, 16V
C471	24590473	PF, 0.047 $\mu$ F
C472	24567474	PF, 0.47 $\mu$ F
C473	24669010	EL, 1 $\mu$ F, $\pm$ 20%, 50V
C475	24095887	PF, 0.01 $\mu$ F, $\pm$ 3%, 630V
C476	24794220	EL, 22 $\mu$ F, $\pm$ 20%, 16V
C477	24590102	PF, 1000pF
C479	24214471	CD, 470pF, $\pm$ 10%, 500V
C481	24085988	EL, 1.0 $\mu$ F, $\pm$ 20%, 50V, Non-Polar
C482	24212152	CD, 1500pF, $\pm$ 10%
C490	24082983	PF, 1.5 $\mu$ F, 250V
C492	24829473	PF, 0.047 $\mu$ F, 400V
C494	24082637	PF, 0.1 $\mu$ F, 400V
C495	24092343	CD, 680pF, $\pm$ 10%, 2kV
C496	24092343	CD, 680pF, $\pm$ 10%, 2kV
C501	24092293	Chip, 0.1 $\mu$ F, +80%, -20%, 25V
C502	24092293	Chip, 0.1 $\mu$ F, +80%, -20%, 25V
C502	24232103	CD, 0.01 $\mu$ F, +80%, -20%
C503	24794221	EL, 220 $\mu$ F, $\pm$ 20%, 16V
C503	24794470	EL, 47 $\mu$ F, $\pm$ 20%, 16V
C504	24814103	Chip, 0.01 $\mu$ F, +80%, -20%
C505	24794470	EL, 47 $\mu$ F, $\pm$ 20%, 16V
C506	24814103	Chip, 0.01 $\mu$ F, +80%, -20%
C507	24092293	Chip, 0.1 $\mu$ F, +80%, -20%, 25V
C508	24092293	Chip, 0.1 $\mu$ F, +80%, -20%, 25V
C508	24797010	EL, 1 $\mu$ F, $\pm$ 20%, 50V
C509	24092293	Chip, 0.1 $\mu$ F, +80%, -20%, 25V
C509	24794101	EL, 100 $\mu$ F, $\pm$ 20%, 16V
C510	24794101	EL, 100 $\mu$ F, $\pm$ 20%, 16V
C510	24797479	EL, 4.7 $\mu$ F, $\pm$ 20%, 50V
C511	24092293	Chip, 0.1 $\mu$ F, +80%, -20%, 25V
C511	24232103	CD, 0.01 $\mu$ F, +80%, -20%
C512	24092293	Chip, 0.1 $\mu$ F, +80%, -20%, 25V
C513	24092293	Chip, 0.1 $\mu$ F, +80%, -20%, 25V
C513	24232103	CD, 0.01 $\mu$ F, +80%, -20%
C514	24567104	PF, 0.1 $\mu$ F
C514	24794470	EL, 47 $\mu$ F, $\pm$ 20%, 16V
C515	24567104	PF, 0.1 $\mu$ F
C515	24814103	Chip, 0.01 $\mu$ F, +80%, -20%
C516	24774100	Chip, 10pF, $\pm$ 0.5pF, CH
C517	24797478	EL, 0.47 $\mu$ F, $\pm$ 20%, 50V
C518	24436101	CD, 100pF
C518	24814103	Chip, 0.01 $\mu$ F, +80%, -20%
C519	24092293	Chip, 0.1 $\mu$ F, +80%, -20%, 25V
C520	24212102	CD, 1000pF, $\pm$ 10%
C520	24797229	EL, 2.2 $\mu$ F, $\pm$ 20%, 50V
C521	24212102	CD, 1000pF, $\pm$ 10%
C521	24567223	PF, 0.022 $\mu$ F
C522	24814103	Chip, 0.01 $\mu$ F, +80%, -20%
C525	24567104	PF, 0.1 $\mu$ F
C555	24092398	CD, 0.1 $\mu$ F, +80%, -20%, 25V
C556	24797010	EL, 1 $\mu$ F, $\pm$ 20%, 50V
C608	24762222	EL, 2200 $\mu$ F, $\pm$ 20%, 10V

Location No.	Part No.	Description
C613	24794471	EL, 470 $\mu$ F, $\pm$ 20%, 16V
C615	24085960	EL, 4.7 $\mu$ F, $\pm$ 20%, 50V, Non-Polar
C616	24590183	PF, 0.018 $\mu$ F
C617	24590102	PF, 1000pF
C618	24590823	PF, 0.082 $\mu$ F
C619	24794221	EL, 220 $\mu$ F, $\pm$ 20%, 16V
C620	24794101	EL, 100 $\mu$ F, $\pm$ 20%, 16V
C631	24567474	PF, 0.47 $\mu$ F
C631	24797010	EL, 1 $\mu$ F, $\pm$ 20%, 50V
C632	24797100	EL, 10 $\mu$ F, $\pm$ 20%, 50V
C632	24797479	EL, 4.7 $\mu$ F, $\pm$ 20%, 50V
C633	24591124	PF, 0.12 $\mu$ F
C633	24781102	Chip, 1000pF, SL
C634	24206100	EL, 10 $\mu$ F, $\pm$ 20%, 50V
C634	24668471	EL, 470 $\mu$ F, $\pm$ 20%, 35V
C635	24814103	Chip, 0.01 $\mu$ F, +80%, -20%
C636	24206100	EL, 10 $\mu$ F, $\pm$ 20%, 50V
C637	24765221	EL, 220 $\mu$ F, $\pm$ 20%, 35V
C638	24814103	Chip, 0.01 $\mu$ F, +80%, -20%
C639	24590103	PF, 0.01 $\mu$ F
C640	24797220	EL, 22 $\mu$ F, $\pm$ 20%, 50V
C641	24206100	EL, 10 $\mu$ F, $\pm$ 20%, 50V
C641	24669010	EL, 1 $\mu$ F, $\pm$ 20%, 50V
C642	24206478	EL, 0.47 $\mu$ F, $\pm$ 20%, 50V
C643	24781102	Chip, 1000pF, SL
C644	24797010	EL, 1 $\mu$ F, $\pm$ 20%, 50V
C645	24795470	EL, 47 $\mu$ F, $\pm$ 20%, 25V
C647	24591102	PF, 1000pF
C648	24591102	PF, 1000pF
C649	24797229	EL, 2.2 $\mu$ F, $\pm$ 20%, 50V
C650	24668102	EL, 1000 $\mu$ F, $\pm$ 20%, 35V
C651	24668471	EL, 470 $\mu$ F, $\pm$ 20%, 35V
C652	24668471	EL, 470 $\mu$ F, $\pm$ 20%, 35V
C654	24591124	PF, 0.12 $\mu$ F
C655	24591124	PF, 0.12 $\mu$ F
C656	24232103	CD, 0.01 $\mu$ F, +80%, -20%
C657	24797229	EL, 2.2 $\mu$ F, $\pm$ 20%, 50V
C661	24797478	EL, 0.47 $\mu$ F, $\pm$ 20%, 50V
C662	24797229	EL, 2.2 $\mu$ F, $\pm$ 20%, 50V
C663	24797229	EL, 2.2 $\mu$ F, $\pm$ 20%, 50V
C665	24797010	EL, 1 $\mu$ F, $\pm$ 20%, 50V
C666	24797010	EL, 1 $\mu$ F, $\pm$ 20%, 50V
C667	24212102	CD, 1000pF, $\pm$ 10%
C667	24797229	EL, 2.2 $\mu$ F, $\pm$ 20%, 50V
C668	24212102	CD, 1000pF, $\pm$ 10%
C668	24590102	PF, 1000pF
C669	24797330	EL, 33 $\mu$ F, $\pm$ 20%, 50V
C670	24797330	EL, 33 $\mu$ F, $\pm$ 20%, 50V
C670	24814103	Chip, 0.01 $\mu$ F, +80%, -20%
C671	24797100	EL, 10 $\mu$ F, $\pm$ 20%, 50V
C671	24814103	Chip, 0.01 $\mu$ F, +80%, -20%
C672	24795470	EL, 47 $\mu$ F, $\pm$ 20%, 25V
C672	24814103	Chip, 0.01 $\mu$ F, +80%, -20%
C673	24781102	Chip, 1000pF, SL
C673	24795470	EL, 47 $\mu$ F, $\pm$ 20%, 25V
C674	24781102	Chip, 1000pF, SL
C674	24797100	EL, 10 $\mu$ F, $\pm$ 20%, 50V
C675	24795470	EL, 47 $\mu$ F, $\pm$ 20%, 25V
C677	24590102	PF, 1000pF
C677	24814103	Chip, 0.01 $\mu$ F, +80%, -20%
C678	24590102	PF, 1000pF
C678	24781102	Chip, 1000pF, SL
C679	24781102	Chip, 1000pF, SL

Location No.	Part No.	Description
C680	24668102	EL, 1000 $\mu$ F, $\pm$ 20%, 35V
C681	24668102	EL, 1000 $\mu$ F, $\pm$ 20%, 35V
C681	24781102	Chip, 1000pF, SL
C682	24668102	EL, 1000 $\mu$ F, $\pm$ 20%, 35V
C682	24781102	Chip, 1000pF, SL
C685	24591124	PF, 0.12 $\mu$ F
C687	24232103	CD, 0.01 $\mu$ F, +80%, -20%
C688	24794220	EL, 22 $\mu$ F, $\pm$ 20%, 16V
C689	24591124	PF, 0.12 $\mu$ F
C704	24591822	PF, 8200pF
C705	24797229	EL, 2.2 $\mu$ F, $\pm$ 20%, 50V
C707	24794470	EL, 47 $\mu$ F, $\pm$ 20%, 16V
C712	24794470	EL, 47 $\mu$ F, $\pm$ 20%, 16V
C713	24790100	EL, 10 $\mu$ F, $\pm$ 20%, 160V
C714	24436101	CD, 100pF
C715	24214472	CD, 4700pF, $\pm$ 10%, 500V
C716	24436101	CD, 100pF
C717	24214472	CD, 4700pF, $\pm$ 10%, 500V
C718	24794470	EL, 47 $\mu$ F, $\pm$ 20%, 16V
C719	24435151	CD, 150pF, 500V, SL
C720	24790100	EL, 10 $\mu$ F, $\pm$ 20%, 160V
C721	24794470	EL, 47 $\mu$ F, $\pm$ 20%, 16V
C805	24092281	CD, 4700pF, $\pm$ 20%, AC250V
C806	24092281	CD, 4700pF, $\pm$ 20%, AC250V
C808	24667331	EL, 330 $\mu$ F, $\pm$ 20%, 25V
C810	24086063	EL, 330 $\mu$ F, $\pm$ 20%, 400V
C810	24763102	EL, 1000 $\mu$ F, $\pm$ 20%, 16V
△C813	24092555	CD, 1000pF, $\pm$ 20%, AC250V
△C814	24092555	CD, 1000pF, $\pm$ 20%, AC250V
C817	24092339	CD, 330pF, $\pm$ 10%, 2kV
C818	24095931	PF, 2200pF, 1250V
C819	24676220	EL, 22 $\mu$ F, $\pm$ 20%, 100V
C821	24214471	CD, 470pF, $\pm$ 10%, 500V
C822	24567474	PF, 0.47 $\mu$ F
C823	24214471	CD, 470pF, $\pm$ 10%, 500V
C829	24590332	PF, 3300pF
C831	24794470	EL, 47 $\mu$ F, $\pm$ 20%, 16V
C832	24794470	EL, 47 $\mu$ F, $\pm$ 20%, 16V
C833	24669100	EL, 10 $\mu$ F, $\pm$ 20%, 50V
C834	24795100	EL, 10 $\mu$ F, $\pm$ 20%, 25V
C835	24794470	EL, 47 $\mu$ F, $\pm$ 20%, 16V
C836	24794470	EL, 47 $\mu$ F, $\pm$ 20%, 16V
C841	24669100	EL, 10 $\mu$ F, $\pm$ 20%, 50V
C842	24669100	EL, 10 $\mu$ F, $\pm$ 20%, 50V
C843	24567104	PF, 0.1 $\mu$ F
C846	24567224	PF, 0.22 $\mu$ F
C872	24669221	EL, 220 $\mu$ F, $\pm$ 20%, 50V
C884	24086916	EL, 330 $\mu$ F, $\pm$ 20%, 160V
C885	24214471	CD, 470pF, $\pm$ 10%, 500V
C887	24214471	CD, 470pF, $\pm$ 10%, 500V
C889	24669102	EL, 1000 $\mu$ F, $\pm$ 20%, 50V
C890	24667222	EL, 2200 $\mu$ F, $\pm$ 20%, 25V
C891	24667332	EL, 3300 $\mu$ F, $\pm$ 20%, 25V
C892	24667222	EL, 2200 $\mu$ F, $\pm$ 20%, 25V
C893	24092337	CD, 220pF, $\pm$ 10%, 2kV
C894	24669102	EL, 1000 $\mu$ F, $\pm$ 20%, 50V
C895	24669470	EL, 47 $\mu$ F, $\pm$ 20%, 50V
C896	24214471	CD, 470pF, $\pm$ 10%, 500V
C897	24667332	EL, 3300 $\mu$ F, $\pm$ 20%, 25V
C898	24567224	PF, 0.22 $\mu$ F
C899	24214471	CD, 470pF, $\pm$ 10%, 500V
C902	24092345	CD, 1000pF, $\pm$ 10%, 2kV
C904	24436471	CD, 470pF
C905	24436471	CD, 470pF

Location No.	Part No.	Description
C907	24436471	CD, 470pF
C909	24679220	EL, 22 $\mu$ F, $\pm$ 20%, 250V
C910	24797478	EL, 0.47 $\mu$ F, $\pm$ 20%, 50V
C911	24203100	EL, 10 $\mu$ F, $\pm$ 20%, 16V
C912	24794102	EL, 1000 $\mu$ F, $\pm$ 20%, 16V
C913	24794101	EL, 100 $\mu$ F, $\pm$ 20%, 16V
C914	24212103	CD, 0.01 $\mu$ F, $\pm$ 10%
C915	24092398	CD, 0.1 $\mu$ F, +80%, -20%, 25V
C920	24591104	PF, 0.1 $\mu$ F
C921	24591104	PF, 0.1 $\mu$ F
C930	24214101	CD, 100pF, $\pm$ 10%, 500V
C931	24214101	CD, 100pF, $\pm$ 10%, 500V
C940	24436390	CD, 39pF
C4376	24590103	PF, 0.01 $\mu$ F
C4405	24590103	PF, 0.01 $\mu$ F
C4408	24590103	PF, 0.01 $\mu$ F
C4418	24590103	PF, 0.01 $\mu$ F
C4425	24797010	EL, 1 $\mu$ F, $\pm$ 20%, 50V
C4426	24794101	EL, 100 $\mu$ F, $\pm$ 20%, 16V
C4447	24590103	PF, 0.01 $\mu$ F
C4490	24082637	PF, 0.1 $\mu$ F, 400V
C4491	24082637	PF, 0.1 $\mu$ F, 400V
CA03	24436180	CD, 18pF(32ZD08G)
CA04	24436180	CD, 18pF(32ZD08G)
CA09	24474101	CD, 100pF, $\pm$ 10%
CA10	24474101	CD, 100pF, $\pm$ 10%
CA12	24212101	CD, 100pF, $\pm$ 10%
CA13	24436101	CD, 100pF
CA15	24474101	CD, 100pF, $\pm$ 10%
CA16	24474101	CD, 100pF, $\pm$ 10%
CA17	24474101	CD, 100pF, $\pm$ 10%
CA33	24232103	CD, 0.01 $\mu$ F, +80%, -20%
CA42	24794100	EL, 10 $\mu$ F, $\pm$ 20%, 16V
CA43	24232103	CD, 0.01 $\mu$ F, +80%, -20%
CA44	24232103	CD, 0.01 $\mu$ F, +80%, -20%
CA68	24794100	EL, 10 $\mu$ F, $\pm$ 20%, 16V
CA69	24232103	CD, 0.01 $\mu$ F, +80%, -20%
CA80	24794470	EL, 47 $\mu$ F, $\pm$ 20%, 16V (32ZD08G)
CA81	24232103	CD, 0.01 $\mu$ F, +80%, -20% (32ZD08G)
CA83	24085981	EL, 10 $\mu$ F, $\pm$ 20%, 16V, Non-Polar (32ZD08G)
CB01	24794470	EL, 47 $\mu$ F, $\pm$ 20%, 16V
CB02	24567104	PF, 0.1 $\mu$ F
CB90	24232103	CD, 0.01 $\mu$ F, +80%, -20%
CC09	24814103	Chip, 0.01 $\mu$ F, +80%, -20%
CC10	24814103	Chip, 0.01 $\mu$ F, +80%, -20%
CC15	24232103	CD, 0.01 $\mu$ F, +80%, -20%
CC16	24474102	CD, 1000pF, $\pm$ 10%
CC20	24781220	Chip, 22pF, SL
CC26	24232103	CD, 0.01 $\mu$ F, +80%, -20%
CC27	24232103	CD, 0.01 $\mu$ F, +80%, -20%
CC45	24814103	Chip, 0.01 $\mu$ F, +80%, -20%
CC46	24814103	Chip, 0.01 $\mu$ F, +80%, -20%
CC89	24781151	Chip, 150pF, SL
CD85	24092293	Chip, 0.1 $\mu$ F, +80%, -20%, 25V
CD86	24793221	EL, 220 $\mu$ F, $\pm$ 20%, 10V
CD87	24815222	Chip, 0.0022 $\mu$ F, $\pm$ 10%
CD88	24794100	EL, 10 $\mu$ F, $\pm$ 20%, 16V
CD89	24092293	Chip, 0.1 $\mu$ F, +80%, -20%, 25V
CF02	24774220	Chip, 22pF, CH(32ZD08G)
CF03	24774220	Chip, 22pF, CH (32ZD08G)
CF03	24567104	PF, 0.1 $\mu$ F (32ZD08B)



Location No.	Part No.	Description
CF04	24766101	EL, 100 $\mu$ F, $\pm$ 20%, 50V (32ZD08B)
CF05	24092293	Chip, 0.1 $\mu$ F, +80%, -20%, 25V (32ZD08G)
CF05	24766101	EL, 100 $\mu$ F, $\pm$ 20%, 50V (32ZD08B)
CF06	24092293	Chip, 0.1 $\mu$ F, +80%, -20%, 25V (32ZD08G)
CF06	24774220	Chip, 22pF, CH(32ZD08B)
CF07	24092293	Chip, 0.1 $\mu$ F, +80%, -20%, 25V (32ZD08G)
CF07	24774220	Chip, 22pF, CH(32ZD08B)
CF08	24092293	Chip, 0.1 $\mu$ F, +80%, -20%, 25V (32ZD08G)
CF08	24567104	PF, 0.1 $\mu$ F (32ZD08B)
CF09	24567224	PF, 0.22 $\mu$ F (32ZD08G)
CF10	24092293	Chip, 0.1 $\mu$ F, +80%, -20%, 25V (32ZD08G)
CF10	24206100	EL, 10 $\mu$ F, $\pm$ 20%, 50V (32ZD08B)
CF11	24202101	EL, 100 $\mu$ F, $\pm$ 20%, 10V (32ZD08G)
CF11	24567104	PF, 0.1 $\mu$ F (32ZD08B)
CF12	24202101	EL, 100 $\mu$ F, $\pm$ 20%, 10V (32ZD08G)
CF12	24814103	Chip, 0.01 $\mu$ F, +80%, -20% (32ZD08B)
CF13	24202101	EL, 100 $\mu$ F, $\pm$ 20%, 10V (32ZD08G)
CF14	24202101	EL, 100 $\mu$ F, $\pm$ 20%, 10V (32ZD08G)
CF14	24814103	Chip, 0.01 $\mu$ F, +80%, -20% (32ZD08B)
CF15	24092293	Chip, 0.1 $\mu$ F, +80%, -20%, 25V (32ZD08G)
CF16	24567224	PF, 0.22 $\mu$ F (32ZD08B)
CF17	24781101	Chip, 100pF, SL(32ZD08G)
CF18	24092293	Chip, 0.1 $\mu$ F, +80%, -20%, 25V (32ZD08G)
CF18	24794101	EL, 100 $\mu$ F, $\pm$ 20%, 16V (32ZD08B)
CF19	24092293	Chip, 0.1 $\mu$ F, +80%, -20%, 25V (32ZD08G)
CF19	24814103	Chip, 0.01 $\mu$ F, +80%, -20% (32ZD08B)
CF20	24092293	Chip, 0.1 $\mu$ F, +80%, -20%, 25V (32ZD08G)
CF20	24766010	EL, 1 $\mu$ F, $\pm$ 20%, 50V (32ZD08B)
CF21	24092293	Chip, 0.1 $\mu$ F, +80%, -20%, 25V (32ZD08G)
CF22	24092293	Chip, 0.1 $\mu$ F, +80%, -20%, 25V (32ZD08G)
CF24	24092293	Chip, 0.1 $\mu$ F, +80%, -20%, 25V (32ZD08G)
CF25	24092293	Chip, 0.1 $\mu$ F, +80%, -20%, 25V (32ZD08G)
CF26	24774330	Chip, 33pF, CH(32ZD08G)
CF31	24203100	EL, 10 $\mu$ F, $\pm$ 20%, 16V (32ZD08G)
CF32	24092293	Chip, 0.1 $\mu$ F, +80%, -20%, 25V (32ZD08G)
CF33	24202101	EL, 100 $\mu$ F, $\pm$ 20%, 10V (32ZD08G)
CF41	24774060	CD, 6pF, $\pm$ 0.5pF, CH (32ZD08G)

Location No.	Part No.	Description
CF42	24774060	CD, 6pF, $\pm$ 0.5pF, CH (32ZD08G)
CF43	24092293	Chip, 0.1 $\mu$ F, +80%, -20%, 25V (32ZD08G)
CF60	24092293	Chip, 0.1 $\mu$ F, +80%, -20%, 25V (32ZD08G)
CF61	24092293	Chip, 0.1 $\mu$ F, +80%, -20%, 25V (32ZD08G)
CG01	24082926	PF, 0.1 $\mu$ F, $\pm$ 20%, AC275V (32ZD08G)
CG06	24073101	EL, 47 $\mu$ F, $\pm$ 20% (32ZD08G)
CG07	24567474	PF, 0.47 $\mu$ F (32ZD08G)
CG08	24214471	CD, 470pF, $\pm$ 10%, 500V (32ZD08G)
CG10	24667331	EL, 330 $\mu$ F, $\pm$ 20%, 25V (32ZD08G)
CG11	24667470	EL, 47 $\mu$ F, $\pm$ 20%, 25V (32ZD08G)
CG12	24212681	CD, 680pF, $\pm$ 10% (32ZD08G)
CG13	24092333	CD, 100pF, $\pm$ 10%, 2kV (32ZD08G)
CG20	24676470	EL, 47 $\mu$ F, $\pm$ 20%, 100V (32ZD08G)
CG27	24666222	EL, 2200 $\mu$ F, $\pm$ 20%, 16V (32ZD08G)
CG34	24794101	EL, 100 $\mu$ F, $\pm$ 20%, 16V (32ZD08G)
CG35	24665470	EL, 47 $\mu$ F, $\pm$ 20%, 10V (32ZD08G)
CG62	24214471	CD, 470pF, $\pm$ 10%, 500V (32ZD08G)
CG65	24214471	CD, 470pF, $\pm$ 10%, 500V (32ZD08G)
CR01	24797010	EL, 1 $\mu$ F, $\pm$ 20%, 50V
CR02	24232103	CD, 0.01 $\mu$ F, +80%, -20%
CR09	24567104	PF, 0.1 $\mu$ F
CR10	24794470	EL, 47 $\mu$ F, $\pm$ 20%, 16V
CR11	24567104	PF, 0.1 $\mu$ F
CR12	24567104	PF, 0.1 $\mu$ F
CR13	24567104	PF, 0.1 $\mu$ F
CR14	24567104	PF, 0.1 $\mu$ F
CR18	24567104	PF, 0.1 $\mu$ F
CR19	24567104	PF, 0.1 $\mu$ F
CR20	24567104	PF, 0.1 $\mu$ F
CS01	24797229	EL, 2.2 $\mu$ F, $\pm$ 20%, 50V
CS02	24797229	EL, 2.2 $\mu$ F, $\pm$ 20%, 50V
CS03	24797229	EL, 2.2 $\mu$ F, $\pm$ 20%, 50V
CS04	24797229	EL, 2.2 $\mu$ F, $\pm$ 20%, 50V
CS05	24206229	EL, 2.2 $\mu$ F, $\pm$ 20%, 50V
CS06	24206229	EL, 2.2 $\mu$ F, $\pm$ 20%, 50V
CS07	24797229	EL, 2.2 $\mu$ F, $\pm$ 20%, 50V
CS08	24797229	EL, 2.2 $\mu$ F, $\pm$ 20%, 50V
CS09	24797229	EL, 2.2 $\mu$ F, $\pm$ 20%, 50V
CS10	24797229	EL, 2.2 $\mu$ F, $\pm$ 20%, 50V
CS12	24781102	Chip, 1000pF, SL
CS13	24781102	Chip, 1000pF, SL
CS14	24797100	EL, 10 $\mu$ F, $\pm$ 20%, 50V
CS15	24797100	EL, 10 $\mu$ F, $\pm$ 20%, 50V
CS17	24794100	EL, 10 $\mu$ F, $\pm$ 20%, 16V
CS18	24794100	EL, 10 $\mu$ F, $\pm$ 20%, 16V
CS19	24797478	EL, 0.47 $\mu$ F, $\pm$ 20%, 50V
CS22	24794100	EL, 10 $\mu$ F, $\pm$ 20%, 16V
CS23	24794100	EL, 10 $\mu$ F, $\pm$ 20%, 16V

Location No.	Part No.	Description
CV02	24092293	Chip, 0.1 $\mu$ F, +80%, -20%, 25V
CV03	24092293	Chip, 0.1 $\mu$ F, +80%, -20%, 25V
CV04	24092293	Chip, 0.1 $\mu$ F, +80%, -20%, 25V
CV05	24814103	Chip, 0.01 $\mu$ F, +80%, -20%
CV06	24092293	Chip, 0.1 $\mu$ F, +80%, -20%, 25V
CV08	24794101	EL, 100 $\mu$ F, $\pm$ 20%, 16V
CV09	24815473	Chip, 0.047 $\mu$ F, $\pm$ 10%
CV10	24794220	EL, 22 $\mu$ F, $\pm$ 20%, 16V
CV12	24092178	Chip, 0.1 $\mu$ F, $\pm$ 10%, 25V
CV14	24781102	Chip, 1000pF, SL
CV15	24781102	Chip, 1000pF, SL
CV16	24781102	Chip, 1000pF, SL
CV17	24781102	Chip, 1000pF, SL
CV18	24781102	Chip, 1000pF, SL
CV19	24781102	Chip, 1000pF, SL
CV23	24203101	EL, 100 $\mu$ F, $\pm$ 20%, 16V
CV24	24814103	Chip, 0.01 $\mu$ F, +80%, -20%
CV35	24814103	Chip, 0.01 $\mu$ F, +80%, -20%
CV39	24794101	EL, 100 $\mu$ F, $\pm$ 20%, 16V
CV40	24814103	Chip, 0.01 $\mu$ F, +80%, -20%
CV46	24212332	CD, 3300pF, $\pm$ 10%
CV47	24212332	CD, 3300pF, $\pm$ 10%
CV48	24212102	CD, 1000pF, $\pm$ 10%
CV65	24203101	EL, 100 $\mu$ F, $\pm$ 20%, 16V
CV66	24794101	EL, 100 $\mu$ F, $\pm$ 20%, 16V
CX101	24794470	EL, 47 $\mu$ F, $\pm$ 20%, 16V
CX102	24085981	EL, 10 $\mu$ F, $\pm$ 20%, 16V, Non-Polar
CX104	24092293	Chip, 0.1 $\mu$ F, +80%, -20%, 25V
CX105	24774330	Chip, 33pF, CH
CX106	24774270	Chip, 270pF, CH
CX107	24774101	Chip, 100pF, CH
CX108	24092293	Chip, 0.1 $\mu$ F, +80%, -20%, 25V
CX111	24092621	Chip, 1 $\mu$ F, $\pm$ 10%, 10V
CX112	24794100	EL, 10 $\mu$ F, $\pm$ 20%, 16V
CX113	24092293	Chip, 0.1 $\mu$ F, +80%, -20%, 25V
CX114	24092293	Chip, 0.1 $\mu$ F, +80%, -20%, 25V
CX115	24092293	Chip, 0.1 $\mu$ F, +80%, -20%, 25V
CX116	24092293	Chip, 0.1 $\mu$ F, +80%, -20%, 25V
CX117	24092293	Chip, 0.1 $\mu$ F, +80%, -20%, 25V
CX118	24794100	EL, 10 $\mu$ F, $\pm$ 20%, 16V
CX119	24794100	EL, 10 $\mu$ F, $\pm$ 20%, 16V
CX120	24794100	EL, 10 $\mu$ F, $\pm$ 20%, 16V
CX121	24774330	Chip, 33pF, CH
CX122	24092293	Chip, 0.1 $\mu$ F, +80%, -20%, 25V
CX123	24092293	Chip, 0.1 $\mu$ F, +80%, -20%, 25V
CX124	24092293	Chip, 0.1 $\mu$ F, +80%, -20%, 25V
CX125	24794100	EL, 10 $\mu$ F, $\pm$ 20%, 16V
CX126	24092293	Chip, 0.1 $\mu$ F, +80%, -20%, 25V
CX128	24092441	Chip, 1 $\mu$ F, +80%, -20%, 16V
CX129	24092293	Chip, 0.1 $\mu$ F, +80%, -20%, 25V
CX130	24092293	Chip, 0.1 $\mu$ F, +80%, -20%, 25V
CX143	24085981	EL, 10 $\mu$ F, $\pm$ 20%, 16V, Non-Polar
CX145	24092293	Chip, 0.1 $\mu$ F, +80%, -20%, 25V
CX148	24774101	Chip, 100pF, CH
CX149	24774470	Chip, 47pF, CH
CX150	24774271	Chip, 270pF, CH
CX151	24092293	Chip, 0.1 $\mu$ F, +80%, -20%, 25V
CX152	24794100	EL, 10 $\mu$ F, $\pm$ 20%, 16V
CX155	24092293	Chip, 0.1 $\mu$ F, +80%, -20%, 25V
CX156	24794100	EL, 10 $\mu$ F, $\pm$ 20%, 16V
CX157	24092293	Chip, 0.1 $\mu$ F, +80%, -20%, 25V
CX159	24092441	Chip, 1 $\mu$ F, +80%, -20%, 16V

Location No.	Part No.	Description
CX160	24092293	Chip, 0.1 $\mu$ F, +80%, -20%, 25V
CX163	24085981	EL, 10 $\mu$ F, $\pm$ 20%, 16V, Non-Polar
CX165	24092293	Chip, 0.1 $\mu$ F, +80%, -20%, 25V
CX168	24774101	Chip, 100pF, CH
CX169	24774470	Chip, 47pF, CH
CX170	24774271	Chip, 270pF, CH
CX171	24092293	Chip, 0.1 $\mu$ F, +80%, -20%, 25V
CX172	24794100	EL, 10 $\mu$ F, $\pm$ 20%, 16V
CX176	24794100	EL, 10 $\mu$ F, $\pm$ 20%, 16V
CX177	24092293	Chip, 0.1 $\mu$ F, +80%, -20%, 25V
CX179	24092441	Chip, 1 $\mu$ F, +80%, -20%, 16V
CX180	24092293	Chip, 0.1 $\mu$ F, +80%, -20%, 25V
CX184	24092293	Chip, 0.1 $\mu$ F, +80%, -20%, 25V
CX185	24092293	Chip, 0.1 $\mu$ F, +80%, -20%, 25V
CX186	24092293	Chip, 0.1 $\mu$ F, +80%, -20%, 25V
CX187	24794100	EL, 10 $\mu$ F, $\pm$ 20%, 16V
CX188	24794100	EL, 10 $\mu$ F, $\pm$ 20%, 16V
CX189	24794100	EL, 10 $\mu$ F, $\pm$ 20%, 16V
CX190	24774330	Chip, 33pF, CH
CX191	24092293	Chip, 0.1 $\mu$ F, +80%, -20%, 25V
CX192	24092293	Chip, 0.1 $\mu$ F, +80%, -20%, 25V
CX193	24092293	Chip, 0.1 $\mu$ F, +80%, -20%, 25V
CX201	24092293	Chip, 0.1 $\mu$ F, +80%, -20%, 25V
CX202	24092293	Chip, 0.1 $\mu$ F, +80%, -20%, 25V
CX204	24092293	Chip, 0.1 $\mu$ F, +80%, -20%, 25V
CX205	24092293	Chip, 0.1 $\mu$ F, +80%, -20%, 25V
CX206	24092293	Chip, 0.1 $\mu$ F, +80%, -20%, 25V
CX208	24092293	Chip, 0.1 $\mu$ F, +80%, -20%, 25V
CX209	24092293	Chip, 0.1 $\mu$ F, +80%, -20%, 25V
CX211	24092293	Chip, 0.1 $\mu$ F, +80%, -20%, 25V
CX212	24092293	Chip, 0.1 $\mu$ F, +80%, -20%, 25V
CX214	24092293	Chip, 0.1 $\mu$ F, +80%, -20%, 25V
CX215	24092293	Chip, 0.1 $\mu$ F, +80%, -20%, 25V
CX216	24092293	Chip, 0.1 $\mu$ F, +80%, -20%, 25V
CX218	24794471	EL, 470 $\mu$ F, $\pm$ 20%, 16V
CX221	24092293	Chip, 0.1 $\mu$ F, +80%, -20%, 25V
CX222	24092293	Chip, 0.1 $\mu$ F, +80%, -20%, 25V
CX224	24092293	Chip, 0.1 $\mu$ F, +80%, -20%, 25V
CX225	24794220	EL, 22 $\mu$ F, $\pm$ 20%, 16V
CX226	24794101	EL, 100 $\mu$ F, $\pm$ 20%, 16V
CX227	24092293	Chip, 0.1 $\mu$ F, +80%, -20%, 25V
CX228	24092293	Chip, 0.1 $\mu$ F, +80%, -20%, 25V
CX230	24092293	Chip, 0.1 $\mu$ F, +80%, -20%, 25V
CX231	24092293	Chip, 0.1 $\mu$ F, +80%, -20%, 25V
CX232	24092293	Chip, 0.1 $\mu$ F, +80%, -20%, 25V
CX234	24092293	Chip, 0.1 $\mu$ F, +80%, -20%, 25V
CX235	24797229	EL, 2.2 $\mu$ F, $\pm$ 20%, 50V
CX236	24794101	EL, 100 $\mu$ F, $\pm$ 20%, 16V
CX237	24092293	Chip, 0.1 $\mu$ F, +80%, -20%, 25V
CX238	24092293	Chip, 0.1 $\mu$ F, +80%, -20%, 25V
CX239	24092293	Chip, 0.1 $\mu$ F, +80%, -20%, 25V
CX240	24092293	Chip, 0.1 $\mu$ F, +80%, -20%, 25V
CX241	24092293	Chip, 0.1 $\mu$ F, +80%, -20%, 25V
CX243	24092293	Chip, 0.1 $\mu$ F, +80%, -20%, 25V
CX244	24092293	Chip, 0.1 $\mu$ F, +80%, -20%, 25V
CX245	24092293	Chip, 0.1 $\mu$ F, +80%, -20%, 25V
CX246	24092293	Chip, 0.1 $\mu$ F, +80%, -20%, 25V
CX247	24092293	Chip, 0.1 $\mu$ F, +80%, -20%, 25V
CX249	24092293	Chip, 0.1 $\mu$ F, +80%, -20%, 25V
CX250	24092293	Chip, 0.1 $\mu$ F, +80%, -20%, 25V
CX251	24794471	EL, 470 $\mu$ F, $\pm$ 20%, 16V
CX261	24092293	Chip, 0.1 $\mu$ F, +80%, -20%, 25V
CX262	24774470	Chip, 47pF, CH

Location No.	Part No.	Description
CX271	24092293	Chip, 0.1 $\mu$ F, +80%, -20%, 25V
CX301	24794100	EL, 10 $\mu$ F, $\pm$ 20%, 16V
CX302	24092293	Chip, 0.1 $\mu$ F, +80%, -20%, 25V
CX303	24092293	Chip, 0.1 $\mu$ F, +80%, -20%, 25V
CX305	24092293	Chip, 0.1 $\mu$ F, +80%, -20%, 25V
CX306	24092293	Chip, 0.1 $\mu$ F, +80%, -20%, 25V
CX308	24092293	Chip, 0.1 $\mu$ F, +80%, -20%, 25V
CX309	24092293	Chip, 0.1 $\mu$ F, +80%, -20%, 25V
CX310	24092293	Chip, 0.1 $\mu$ F, +80%, -20%, 25V
CX321	24794100	EL, 10 $\mu$ F, $\pm$ 20%, 16V
CX323	24092293	Chip, 0.1 $\mu$ F, +80%, -20%, 25V
CX326	24774680	Chip, 68pF, CH
CX328	24774330	Chip, 33pF, CH
CX330	24794470	EL, 47 $\mu$ F, $\pm$ 20%, 16V
CX341	24794100	EL, 10 $\mu$ F, $\pm$ 20%, 16V
CX343	24092293	Chip, 0.1 $\mu$ F, +80%, -20%, 25V
CX346	24774181	Chip, 180pF, CH
CX348	24774181	Chip, 180pF, CH
CX361	24794100	EL, 10 $\mu$ F, $\pm$ 20%, 16V
CX363	24092293	Chip, 0.1 $\mu$ F, +80%, -20%, 25V
CX366	24774181	Chip, 180pF, CH
CX368	24774181	Chip, 180pF, CH
CX401	24092293	Chip, 0.1 $\mu$ F, +80%, -20%, 25V
CX402	24092293	Chip, 0.1 $\mu$ F, +80%, -20%, 25V
CX403	24092293	Chip, 0.1 $\mu$ F, +80%, -20%, 25V
CX404	24092293	Chip, 0.1 $\mu$ F, +80%, -20%, 25V
CX405	24794471	EL, 470 $\mu$ F, $\pm$ 20%, 16V
CX406	24794471	EL, 470 $\mu$ F, $\pm$ 20%, 16V
CX407	24774220	Chip, 22pF, CH
CX408	24774220	Chip, 22pF, CH
CX409	24774220	Chip, 22pF, CH
CX410	24774220	Chip, 22pF, CH
CX411	24774220	Chip, 22pF, CH
CX412	24774220	Chip, 22pF, CH
CX421	24774221	Chip, 220pF, CH
CX422	24774221	Chip, 220pF, CH
CX423	24774221	Chip, 220pF, CH
CX424	24774221	Chip, 220pF, CH
CX425	24774221	Chip, 220pF, CH
CX427	24774221	Chip, 220pF, CH
CX428	24774330	Chip, 33pF, CH
CX429	24774330	Chip, 33pF, CH
CX430	24774221	Chip, 220pF, CH
CX431	24073020	EL, 1000 $\mu$ F, $\pm$ 20%, 10V
CX432	24092294	Chip, 0.33 $\mu$ F, +80%, -20%, 16V
CX433	24092293	Chip, 0.1 $\mu$ F, +80%, -20%, 25V
CX434	24092441	Chip, 1 $\mu$ F, +80%, -20%, 16V
CX435	24092293	Chip, 0.1 $\mu$ F, +80%, -20%, 25V
CZ01	24092293	Chip, 0.1 $\mu$ F, +80%, -20%
CZ02	24814103	Chip, 0.01 $\mu$ F, +80%, -20%
CZ03	24092442	Chip, 0.47 $\mu$ F, +80%, -20%, 16V
CZ05	24814103	Chip, 0.01 $\mu$ F, +80%, -20%
CZ07	24092293	Chip, 0.1 $\mu$ F, +80%, -20%, 25V
CZ09	24781220	Chip, 22pF, SL
CZ10	24781100	Chip, 10pF, $\pm$ 0.5pF%, SL
CZ11	24781220	Chip, 22pF, SL
CZ12	24814103	Chip, 0.01 $\mu$ F, +80%, -20%
CZ13	24814103	Chip, 0.01 $\mu$ F, +80%, -20%
CZ14	24794100	EL, 10 $\mu$ F, $\pm$ 20%, 16V
CZ17	24814103	Chip, 0.01 $\mu$ F, +80%, -20%
CZ19	24781181	Chip, 180pF, SL
CZ20	24814103	Chip, 0.01 $\mu$ F, +80%, -20%

Location No.	Part No.	Description
CZ21	24781122	Chip, 1200pF, SL
CZ22	24794100	EL, 10 $\mu$ F, $\pm$ 20%, 16V
CZ23	24814103	Chip, 0.01 $\mu$ F, +80%, -20%
CZ24	24814103	Chip, 0.01 $\mu$ F, +80%, -20%
CZ25	24794100	EL, 10 $\mu$ F, $\pm$ 20%, 16V
CZ26	24814103	Chip, 0.01 $\mu$ F, +80%, -20%
CZ28	24814103	Chip, 0.01 $\mu$ F, +80%, -20%
CZ29	24814103	Chip, 0.01 $\mu$ F, +80%, -20%
CZ30	24794100	EL, 10 $\mu$ F, $\pm$ 20%, 16V
CZ31	24092293	Chip, 0.1 $\mu$ F, +80%, -20%, 25V
CZ32	24781101	Chip, 100pF, SL
CZ33	24781270	Chip, 27pF, SL
CZ34	24781101	Chip, 100pF, SL
CZ35	24781270	Chip, 27pF, SL
CZ37	24814103	Chip, 0.01 $\mu$ F, +80%, -20%
CZ45	24781100	Chip, 10pF, $\pm$ 0.5pF%, SL

**RESISTORS**

R101	24366101	CF, 100 ohm(32ZD08G)
R101	24553223	OMF, 22k ohm, 1W (32ZD08B)
R102	24366103	CF, 10k ohm
R204	24366104	CF, 100k ohm
R205	24366101	CF, 100 ohm
R206	24366471	CF, 470 ohm
R208	24366103	CF, 10k ohm
R209	24366103	CF, 10k ohm
R210	24366101	CF, 100 ohm
R211	24366101	CF, 100 ohm
R211	24366473	CF, 47k ohm
R212	24366101	CF, 100 ohm
R213	24366681	CF, 680 ohm
R214	24366681	CF, 680 ohm
R215	24366681	CF, 680 ohm
R216	24366103	CF, 10k ohm
R217	24366392	CF, 3900 ohm
R218	24366101	CF, 100 ohm
R219	24366101	CF, 100 ohm
R219	24366473	CF, 47k ohm
R220	24366101	CF, 100 ohm
R223	24366472	CF, 4700 ohm
R227	24366223	CF, 22k ohm
R229	24366472	CF, 4700 ohm
R231	24366222	CF, 2200 ohm
R235	24366222	CF, 2200 ohm
R236	24366101	CF, 100 ohm
R237	24366101	CF, 100 ohm
R238	24366562	CF, 5600 ohm
R260	24366222	CF, 2200 ohm
R261	24366681	CF, 680 ohm
R262	24366102	CF, 1k ohm
R263	24366102	CF, 1k ohm
R264	24366103	CF, 10k ohm
R265	24366392	CF, 3900 ohm
R266	24366332	CF, 3300 ohm
R267	24366101	CF, 100 ohm
R269	24366151	CF, 150 ohm
R270	24366102	CF, 1k ohm
R271	24366472	CF, 4700 ohm
R271	24872103	Chip, 10k ohm, 1/16W
R272	24872103	Chip, 10k ohm, 1/16W
R303	24321109	MF, 1 ohm, 1/2W
R305	24339518	MF, 0.51 ohm, 2W
R306	24339518	MF, 0.51 ohm, 2W

Location No.	Part No.	Description
R307	24366101	CF, 100 ohm
R310	24366511	CF, 510 ohm
R311	24366911	CF, 910 ohm
R312	24366153	CF, 15k ohm
R313	24552132	OMF, 1300 ohm, 1/2W
R314	24366102	CF, 1k ohm
R315	24366332	CF, 3300 ohm
R315	24366474	CF, 470k ohm
R316	24366394	CF, 390k ohm
R317	24366511	CF, 510 ohm
R318	24366101	CF, 100 ohm
R319	24366101	CF, 100 ohm
R320	24366155	CF, 1.5M ohm
R321	24552392	OMF, 3900 ohm, 1/2W
R322	24366102	CF, 1k ohm
R323	24366103	CF, 10k ohm
R324	24366681	CF, 680 ohm
R325	24366103	CF, 10k ohm
R326	24339109	MF, 1 ohm, 2W
R327	24339109	MF, 1 ohm, 2W
R328	24366102	CF, 1k ohm
R330	24366103	CF, 10k ohm
R331	24366104	CF, 100k ohm
R333	24552912	OMF, 9100 ohm, 1/2W
R335	24366103	CF, 10k ohm
R336	24383181	OMF, 180 ohm, 2W
R338	24003898	MF, 3300 ohm, 1/4W
R341	24366822	CF, 8200 ohm
R343	24366273	CF, 27k ohm
R353	24366471	CF, 470 ohm
R370	24366822	CF, 8200 ohm
R371	24366103	CF, 10k ohm
R373	24366103	CF, 10k ohm
R374	24366472	CF, 4700 ohm
R375	24552150	OMF, 15 ohm, 1/2W
R400	24946561	CC, 560 ohm, 1/2W
R402	24366102	CF, 1k ohm
R403	24366302	CF, 3k ohm
R405	24553682	OMF, 6800 ohm, 1W
R407	24366103	CF, 10k ohm
R411	24366180	CF, 18 ohm
R414	24531560	FR, 56 ohm, 1/2W
R415	24366101	CF, 100 ohm
R415	24553561	OMF, 560 ohm, 1W
R416	24381563	OMF, 56k ohm, 1/2W
R417	24510101	Cement, 100 ohm, 5W
R424	24366152	CF, 1500 ohm
R425	24366182	CF, 1800 ohm
R426	24366751	CF, 750 ohm
R427	24366392	CF, 3900 ohm
R428	24366561	CF, 560 ohm
R429	24552560	OMF, 56 ohm, 1/2W
R431	24366103	CF, 10k ohm(32ZD08B)
R432	24366473	CF, 47k ohm(32ZD08B)
R433	24366681	CF, 680 ohm
R434	24366472	CF, 4700 ohm
R435	24366184	CF, 180k ohm
R441	24383561	OMF, 560 ohm, 2W
R445	24321129	MF, 1.2 ohm, 1/2W
R460	24552332	OMF, 3300 ohm, 1/2W
R461	24381182	OMF, 1800 ohm, 1/2W
R462	24366333	CF, 33k ohm
R463	24323229	MF, 2.2 ohm, 2W
R464	24366273	CF, 27k ohm

Location No.	Part No.	Description
R465	24366101	CF, 100 ohm
R466	24366272	CF, 2700 ohm
R467	24327224	MF, 220k ohm, $\pm 1\%$ , 1/4W
R469	24000211	FR, 15 ohm, 1/2W
R470	24339568	MF, 0.56 ohm, 2W
R471	24531271	FR, 270 ohm, 1/2W
R472	24366101	CF, 100 ohm
R473	24366183	CF, 18k ohm
R473	24366334	CF, 330k ohm
R474	24376393	CF, 39k ohm, 1/2W
R476	24366471	CF, 470 ohm
R477	24366102	CF, 1k ohm
R478	24381333	OMF, 33k ohm, 1/2W
R479	24531680	FR, 68 ohm, 1/2W
R480	24552222	OMF, 2200 ohm, 1/2W
R481	24366223	CF, 22k ohm
R482	24366183	CF, 18k ohm
R483	24366223	CF, 22k ohm
R487	24366474	CF, 470k ohm
R488	24366154	CF, 150k ohm
R489	24366102	CF, 1k ohm
R490	24366101	CF, 100 ohm
R491	24366101	CF, 100 ohm
R492	24366472	CF, 4700 ohm
R499	24366101	CF, 100 ohm
R501	24872682	Chip, 6800 ohm, 1/16W
R502	24366101	CF, 100 ohm
R502	24872272	Chip, 2700 ohm, 1/16W
R503	24366101	CF, 100 ohm
R504	24872101	Chip, 100 ohm, 1/16W
R505	24872101	Chip, 100 ohm, 1/16W
R506	24872273	Chip, 27k ohm, 1/16W
R507	24872392	Chip, 3900 ohm, 1/16W
R512	24872102	Chip, 1k ohm, 1/16W
R513	24366472	CF, 4700 ohm
R513	24872102	Chip, 1k ohm, 1/16W
R514	24366101	CF, 100 ohm
R514	24872102	Chip, 1k ohm, 1/16W
R515	24872102	Chip, 1k ohm, 1/16W
R516	24872102	Chip, 1k ohm, 1/16W
R517	24872102	Chip, 1k ohm, 1/16W
R518	24366102	CF, 1k ohm
R518	24366681	CF, 680 ohm
R519	24872472	Chip, 4700 ohm, 1/16W
R520	24872103	Chip, 10k ohm, 1/16W
R521	24872103	Chip, 10k ohm, 1/16W
R609	24366563	CF, 56k ohm
R610	24366103	CF, 10k ohm
R611	24366103	CF, 10k ohm
R612	24366103	CF, 10k ohm
R613	24366224	CF, 220k ohm
R615	24366223	CF, 22k ohm
R616	24366333	CF, 33k ohm
R617	24366472	CF, 4700 ohm
R618	24366223	CF, 22k ohm
R619	24366472	CF, 4700 ohm
R620	24366153	CF, 15k ohm
R621	24366333	CF, 33k ohm
R622	24366392	CF, 3900 ohm
R623	24366332	CF, 3300 ohm
R624	24366103	CF, 10k ohm
R625	24366103	CF, 10k ohm
R626	24366562	CF, 5600 ohm
R627	24366102	CF, 1k ohm

Location No.	Part No.	Description
R628	24366102	CF, 1k ohm
R631	24552122	OMF, 1200 ohm, 1/2W
R632	24872183	Chip, 18k ohm, 1/16W
R633	24872101	Chip, 100 ohm, 1/16W
R634	24366229	CF, 2.2 ohm
R634	24872332	Chip, 3300 ohm, 1/16W
R635	24872563	Chip, 56k ohm, 1/16W
R636	24872103	Chip, 10k ohm, 1/16W
R637	24366472	CF, 4700 ohm
R637	24872103	Chip, 10k ohm, 1/16W
R638	24872563	Chip, 56k ohm, 1/16W
R639	24366223	CF, 22k ohm
R639	24872153	Chip, 15k ohm, 1/16W
R640	24366472	CF, 4700 ohm
R640	24872153	Chip, 15k ohm, 1/16W
R641	24366182	CF, 1800 ohm
R641	24872153	Chip, 15k ohm, 1/16W
R642	24366562	CF, 5600 ohm
R642	24872182	Chip, 1800 ohm, 1/16W
R643	24366222	CF, 2200 ohm
R643	24872104	Chip, 100k ohm, 1/16W
R644	24366473	CF, 47k ohm
R644	24872104	Chip, 100k ohm, 1/16W
R645	24366229	CF, 2.2 ohm
R645	24872102	Chip, 1k ohm, 1/16W
R646	24366223	CF, 22k ohm
R646	24872681	Chip, 680 ohm, 1/16W
R647	24872223	Chip, 22k ohm, 1/16W
R648	24366229	CF, 2.2 ohm
R648	24872223	Chip, 22k ohm, 1/16W
R649	24366223	CF, 22k ohm
R661	24510159	Cement, 1.5 ohm, 5W
R661	24552221	OMF, 220 ohm, 1/2W
R662	24366104	CF, 100k ohm
R662	24552221	OMF, 220 ohm, 1/2W
R670	24366472	CF, 4700 ohm
R671	24366102	CF, 1k ohm
R671	24366222	CF, 2200 ohm
R672	24366102	CF, 1k ohm
R672	24366472	CF, 4700 ohm
R673	24366102	CF, 1k ohm
R673	24366222	CF, 2200 ohm
R674	24366102	CF, 1k ohm
R676	24366223	CF, 22k ohm
R676	24872223	Chip, 22k ohm, 1/16W
R677	24366223	CF, 22k ohm
R677	24872223	Chip, 22k ohm, 1/16W
R678	24366562	CF, 5600 ohm
R678	24872223	Chip, 22k ohm, 1/16W
R679	24366562	CF, 5600 ohm
R679	24872223	Chip, 22k ohm, 1/16W
R681	24366104	CF, 100k ohm
R684	24366229	CF, 2.2 ohm
R685	24366229	CF, 2.2 ohm
R687	24366222	CF, 2200 ohm
R688	24366222	CF, 2200 ohm
R689	24366104	CF, 100k ohm
R692	24872681	Chip, 680 ohm, 1/16W
R693	24872681	Chip, 680 ohm, 1/16W
R702	24552221	OMF, 220 ohm, 1/2W
R712	24366101	CF, 100 ohm
R715	24366223	CF, 22k ohm
R716	24366273	CF, 27k ohm
R717	24366183	CF, 18k ohm

Location No.	Part No.	Description
R718	24366681	CF, 680 ohm
R722	24552471	OMF, 470 ohm, 1/2W
R723	24366101	CF, 100 ohm
R724	24366181	CF, 180 ohm
R725	24366821	CF, 820 ohm
R730	24552100	OMF, 10 ohm, 1/2W
R731	24553331	OMF, 330 ohm, 1W
R732	24366220	CF, 22 ohm
R733	24366683	CF, 68k ohm
R734	24366220	CF, 22 ohm
R735	24366683	CF, 68k ohm
R736	24366470	CF, 47 ohm
R737	24366681	CF, 680 ohm
R738	24366102	CF, 1k ohm
R739	24366681	CF, 680 ohm
R740	24366470	CF, 47 ohm
R741	24366229	CF, 2.2 ohm
R742	24366229	CF, 2.2 ohm
R743	24554101	OMF, 100 ohm, 2W
R744	24366122	CF, 1200 ohm
R745	24366122	CF, 1200 ohm
△R801	24009954	Metal-Glazed Resistor, 2.2M ohm, 1/2W
R803	24383333	OMF, 33k ohm, 2W
R804	24366334	CF, 330k ohm
R805	24366681	CF, 680 ohm
R807	24366334	CF, 330k ohm
R808	24019484	PTC Thermistor, 4.5 ohm
R809	24366393	CF, 39k ohm
R810	24568159	Cement, 1.5 ohm, 7W
R814	24366682	CF, 6800 ohm
R815	24366332	CF, 3300 ohm
R818	24019460	MF, 0.1 ohm, 2W
R819	24310829	MF, 8.2 ohm, 1/2W
R821	24366101	CF, 100 ohm
R822	24552103	OMF, 10k ohm, 1/2W
R823	24552822	OMF, 8200 ohm, 1/2W
R824	24569689	Cement, 6.8 ohm, 10W
R827	24366681	CF, 680 ohm
R828	24366821	CF, 820 ohm
R829	24321338	MF, 0.33 ohm, 1/2W
R831	24366471	CF, 470 ohm
R832	24366472	CF, 4700 ohm
R833	24366222	CF, 2200 ohm
R834	24366471	CF, 470 ohm
R835	24322229	MF, 2.2 ohm, 1W (32ZD08B)
R841	24531120	FR, 12 ohm, 1/2W (32ZD08B)
R842	24552392	OMF, 3900 ohm, 1/2W (32ZD08B)
R843	24366331	CF, 330 ohm
R846	24366101	CF, 100 ohm
R847	24366472	CF, 4700 ohm (32ZD08B)
R849	24366471	CF, 470 ohm
R850	24366103	CF, 10k ohm
R851	24366102	CF, 1k ohm
R852	24366225	CF, 2.2M ohm
R865	24366332	CF, 3300 ohm (32ZD08G)
R868	24366472	CF, 4700 ohm (32ZD08B)
R875	24366332	CF, 3300 ohm (32ZD08G)
R876	24366103	CF, 10k ohm (32ZD08G)
R891	24383102	OMF, 1k ohm, 2W (32ZD08G)
△R899	24005015	Metal-Glazed Resistor, 8.2M ohm, 1W
R901	24376561	CF, 560 ohm, 1/2W

Location No.	Part No.	Description
R902	24376561	CF, 560 ohm, 1/2W
R903	24376561	CF, 560 ohm, 1/2W
R904	24366472	CF, 4700 ohm
R905	24366150	CF, 15 ohm
R909	24366100	CF, 10 ohm
R914	24366471	CF, 470 ohm
R915	24366680	CF, 68 ohm
R916	24366180	CF, 18 ohm
R917	24366471	CF, 470 ohm
R918	24366180	CF, 18 ohm
R920	24000880	FR, 5.1 ohm, 1W
R921	24366471	CF, 470 ohm
R922	24366680	CF, 68 ohm
R924	24366180	CF, 18 ohm
R925	24366471	CF, 470 ohm
R928	24366471	CF, 470 ohm
R929	24366680	CF, 68 ohm
R930	24366180	CF, 18 ohm
R932	24366332	CF, 3300 ohm
R933	24366750	CF, 75 ohm
R934	24366361	CF, 360 ohm
R935	24366102	CF, 1k ohm
R936	24366750	CF, 75 ohm
R937	24366471	CF, 470 ohm
R939	24366680	CF, 68 ohm
R942	24366392	CF, 3900 ohm
R943	24366392	CF, 3900 ohm
R944	24366392	CF, 3900 ohm
R945	24366180	CF, 18 ohm
R946	24366180	CF, 18 ohm
R960	24383153	OMF, 15k ohm, 2W
R961	24383153	OMF, 15k ohm, 2W
R962	24383153	OMF, 15k ohm, 2W
R963	24383153	OMF, 15k ohm, 2W
R964	24383153	OMF, 15k ohm, 2W
R965	24383153	OMF, 15k ohm, 2W
R966	24383153	OMF, 15k ohm, 2W
R967	24383153	OMF, 15k ohm, 2W
R968	24383153	OMF, 15k ohm, 2W
R969	24366101	CF, 100 ohm
R970	24366101	CF, 100 ohm
R971	24366101	CF, 100 ohm
R977	24366561	CF, 560 ohm
R980	24366471	CF, 470 ohm
R981	24366471	CF, 470 ohm
R982	24366682	CF, 6800 ohm
R983	24366222	CF, 2200 ohm
R984	24366821	CF, 820 ohm
R985	24367471	CF, 470 ohm, $\pm 2\%$
R986	24367681	CF, 680 ohm, $\pm 2\%$
R987	24367681	CF, 680 ohm, $\pm 2\%$
R988	24367472	CF, 4700 ohm, $\pm 2\%$
R989	24367472	CF, 4700 ohm, $\pm 2\%$
R990	24366561	CF, 560 ohm
R991	24367391	CF, 390 ohm, $\pm 2\%$
R992	24366150	CF, 15 ohm
R4222	24366472	CF, 4700 ohm
R4223	24366103	CF, 10k ohm
R4224	24366272	CF, 2700 ohm
R4225	24366102	CF, 1k ohm
R4310	24366183	CF, 18k ohm
R4403	24366101	CF, 100 ohm
R4404	24366101	CF, 100 ohm
R4406	24366752	CF, 7500 ohm

Location No.	Part No.	Description
R4407	24366361	CF, 360 ohm
R4410	24366103	CF, 10k ohm
R4416	24366101	CF, 100 ohm
R4417	24366101	CF, 100 ohm
R4418	24366102	CF, 1k ohm
R4419	24366103	CF, 10k ohm
R4425	24552471	OMF, 470 ohm, 1/2W
R4426	24366152	CF, 1500 ohm
R4461	24366102	CF, 1k ohm
R4462	24366133	CF, 13k ohm
R4463	24366682	CF, 6800 ohm
R4464	24366223	CF, 22k ohm
R4472	24366103	CF, 10k ohm
R4490	24382222	OMF, 2200 ohm, 1W
R4491	24366392	CF, 3900 ohm
R4492	24366103	CF, 10k ohm
R4493	24382104	OMF, 100k ohm, 1W
R4495	24366473	CF, 47k ohm
R4799	24366103	CF, 10k ohm
RA01	24366102	CF, 1k ohm
RA03	24366102	CF, 1k ohm
RA04	24366102	CF, 1k ohm
RA05	24366102	CF, 1k ohm
RA07	24366102	CF, 1k ohm
RA08	24366102	CF, 1k ohm
RA09	24366682	CF, 6800 ohm
RA10	24366682	CF, 6800 ohm
RA11	24366331	CF, 330 ohm
RA12	24366331	CF, 330 ohm
RA13	24366153	CF, 15k ohm
RA14	24366102	CF, 1k ohm
RA16	24366102	CF, 1k ohm
RA17	24366102	CF, 1k ohm
RA18	24366102	CF, 1k ohm
RA19	24366331	CF, 330 ohm
RA20	24366331	CF, 330 ohm
RA21	24366331	CF, 330 ohm
RA22	24366331	CF, 330 ohm
RA23	24366472	CF, 4700 ohm
RA24	24366472	CF, 4700 ohm
RA25	24366103	CF, 10k ohm
RA26	24366102	CF, 1k ohm
RA27	24366102	CF, 1k ohm
RA29	24366102	CF, 1k ohm
RA29	24366104	CF, 100k ohm
RA30	24366102	CF, 1k ohm
RA30	24366103	CF, 10k ohm
RA31	24366561	CF, 560 ohm
RA33	24366103	CF, 10k ohm
RA35	24366102	CF, 1k ohm
RA37	24366101	CF, 100 ohm
RA38	24366101	CF, 100 ohm
RA40	24366331	CF, 330 ohm
RA41	24366273	CF, 27k ohm
RA43	24366102	CF, 1k ohm
RA44	24366103	CF, 10k ohm
RA62	24366102	CF, 1k ohm
RA63	24366102	CF, 1k ohm
RA65	24366103	CF, 10k ohm
RA66	24366103	CF, 10k ohm
RA67	24366472	CF, 4700 ohm
RA68	24366472	CF, 4700 ohm
RA70	24366333	CF, 33k ohm
RA71	24366683	CF, 68k ohm

Location No.	Part No.	Description
RA72	24366223	CF, 22k ohm
RA73	24366103	CF, 10k ohm
RA75	24366333	CF, 33k ohm
RA76	24366103	CF, 10k ohm
RA77	24366223	CF, 22k ohm
RA78	24366102	CF, 1k ohm
RA78	24366683	CF, 68k ohm
RA80	24366331	CF, 330 ohm(32ZD08G)
RA81	24366331	CF, 330 ohm(32ZD08G)
RA82	24366103	CF, 10k ohm(32ZD08G)
RA85	24366102	CF, 1k ohm
RA89	24366152	CF, 1500 ohm
RB01	24366271	CF, 270 ohm
RB02	24366271	CF, 270 ohm
RB03	24366101	CF, 100 ohm
RB04	24366223	CF, 22k ohm
RB05	24366223	CF, 22k ohm
RB07	24366271	CF, 270 ohm
RB08	24366271	CF, 270 ohm
RB09	24366470	CF, 47 ohm
RB10	24366101	CF, 100 ohm
RB11	24366103	CF, 10k ohm
RB30	24366103	CF, 10k ohm
RB43	24366103	CF, 10k ohm
RB44	24366103	CF, 10k ohm
RB45	24366101	CF, 100 ohm
RB81	24366122	CF, 1200 ohm
RB82	24366123	CF, 12k ohm
RB83	24366123	CF, 12k ohm
RB84	24366562	CF, 5600 ohm
RB90	24366392	CF, 3900 ohm
RB91	24366473	CF, 47k ohm
RB92	24366271	CF, 270 ohm
RB93	24366271	CF, 270 ohm
RB94	24366222	CF, 2200 ohm
RB95	24366222	CF, 2200 ohm
RB96	24366273	CF, 27k ohm
RB97	24366273	CF, 27k ohm
RB98	24366102	CF, 1k ohm
RC01	24000824	Chip, Jumper, 2125 type
RC02	24000824	Chip, Jumper, 2125 type
RD06	24366102	CF, 1k ohm (32ZD08G)
RD08	24366102	CF, 1k ohm
RD10	24366102	CF, 1k ohm (32ZD08G)
RD16	24366333	CF, 33k ohm
RD28	24366102	CF, 1k ohm
RD85	24872151	Chip, 150 ohm, 1/16W
RD87	24872151	Chip, 150 ohm, 1/16W
RD88	24872222	Chip, 2200 ohm, 1/16W
RD89	24872151	Chip, 150 ohm, 1/16W
RF01	24872332	Chip, 3300 ohm, 1/16W (32ZD08B)
RF03	24872682	Chip, 6800 ohm, 1/16W (32ZD08B)
RF04	24872223	Chip, 22k ohm, 1/16W (32ZD08B)
RF05	24872682	Chip, 6800 ohm, 1/16W (32ZD08G)
RF06	24872223	Chip, 22k ohm, 1/16W (32ZD08G)
RF06	24872102	Chip, 1k ohm, 1/16W (32ZD08B)
RF07	24872332	Chip, 3300 ohm, 1/16W (32ZD08G)

Location No.	Part No.	Description
RF08	23103832	Chip (Ferrite Bead), TEM2125M (32ZD08B)
RF09	24872683	Chip, 68k ohm, 1/16W (32ZD08G)
RF09	23103832	Chip (Ferrite Bead), TEM2125M (32ZD08B)
RF10	24872103	Chip, 10k ohm, 1/16W (32ZD08G)
RF10	23103832	Chip (Ferrite Bead), TEM2125M (32ZD08B)
RF11	24872471	Chip, 470 ohm, 1/16W (32ZD08G)
RF11	24872103	Chip, 10k ohm, 1/16W (32Z08B)
RF12	24872104	Chip, 100k ohm, 1/16W (32ZD08G)
RF12	24872101	Chip, 100 ohm, 1/16W (32ZD08B)
RF13	24872101	Chip, 100 ohm, 1/16W (32ZD08B)
RF14	24872101	Chip, 100 ohm, 1/16W (32ZD08B)
RF15	24872103	Chip, 10k ohm, 1/16W (32Z08B)
RF16	24872152	Chip, 1500 ohm, 1/16W (32ZD08G)
RF16	24872471	Chip, 470 ohm, 1/16W (32ZD98B)
RF17	24872102	Chip, 1k ohm, 1/16W (32ZD08G)
RF18	24872103	Chip, 10k ohm, 1/16W (32ZD08G)
RF19	24872102	Chip, 1k ohm, 1/16W (32ZD08G)
RF20	24872101	Chip, 100 ohm, 1/16W (32ZD08G)
RF20	24872152	Chip, 1500 ohm, 1/16W (32ZD08B)
RF21	24872101	Chip, 100 ohm, 1/16W (32ZD08G)
RF21	24000824	Chip, Jumper, 2125 type (32ZD08B)
RF22	24872101	Chip, 100 ohm, 1/16W (32ZD08G)
RF22	24872102	Chip, 1k ohm, 1/16W (32ZD08B)
RF23	24872101	Chip, 100 ohm, 1/16W (32ZD08G)
RF24	24872332	Chip, 3300 ohm, 1/16W (32ZD08G)
RF25	24872332	Chip, 3300 ohm, 1/16W (32ZD08G)
RF26	24872102	Chip, 1k ohm, 1/16W (32ZD08B)
RF31	24872103	Chip, 10k ohm, 1/16W (32ZD08G)
RF32	24872103	Chip, 10k ohm, 1/16W (32ZD08G)
RF32	24872101	Chip, 100 ohm, 1/16W (32ZD08B)
RF33	24872103	Chip, 10k ohm, 1/16W (32ZD08G)
RF34	24872103	Chip, 10k ohm, 1/16W (32ZD08G)

Location No.	Part No.	Description
RF34	24872102	Chip, 1k ohm, 1/16W (32ZD08B)
RF36	24872103	Chip, 10k ohm, 1/16W (32ZD08G)
RF37	24872103	Chip, 10k ohm, 1/16W (32ZD08G)
RF38	24872103	Chip, 10k ohm, 1/16W (32ZD08G)
RF39	24872472	Chip, 4700 ohm, 1/16W (32ZD08B)
RF41	24872103	Chip, 10k ohm, 1/16W (32ZD08G)
RF42	24872473	Chip, 47k ohm, 1/16W (32ZD08G)
RF43	24872332	Chip, 3300 ohm, 1/16W (32ZD08G)
RF44	24872332	Chip, 3300 ohm, 1/16W (32ZD08G)
RF45	24872103	Chip, 10k ohm, 1/16W (32ZD08G)
RF46	24872471	Chip, 470 ohm, 1/16W (32ZD08G)
RF47	24000824	Chip, Jumper, 2125 type (32ZD08G)
RF49	24872472	Chip, 4700 ohm, 1/16W (32ZD08G)
RF51	24872103	Chip, 10k ohm, 1/16W (32ZD08G)
RF52	24872332	Chip, 3300 ohm, 1/16W (32ZD08G)
RF53	24872472	Chip, 4700 ohm, 1/16W (32ZD08G)
RF54	24872103	Chip, 10k ohm, 1/16W (32ZD08G)
RF55	24872151	Chip, 150 ohm, 1/16W (32ZD08G)
RF56	24872102	Chip, 1k ohm, 1/16W (32ZD08G)
RG03	24007045	Cement, 3.9 ohm, 5W (32ZD08G)
RG04	24376154	CF, 150k ohm, 1/2W (32ZD08G)
RG05	24310829	MF, 8.2 ohm, 1/2W(32ZD08G)
RG11	24366471	CF, 470 ohm(32ZD08G)
RG12	24310279	MF, 2.7 ohm, 1/2W(32ZD08G)
RG17	24366103	CF, 10k ohm(32ZD08G)
RG18	24366472	CF, 4700 ohm(32ZD08G)
RG19	24366103	CF, 10k ohm(32ZD08G)
RG20	24366331	CF, 330 ohm(32ZD08G)
RG21	24310829	MF, 8.2 ohm, 1/2W(32ZD08G)
RG22	24323229	MF, 2.2 ohm, 2W(32ZD08G)
RG23	24321228	MF, 0.22 ohm, 1/2W (32ZD08G)
RG24	24383331	OMF, 330 ohm, 2W (32ZD08G)
RG25	24383331	OMF, 330 ohm, 2W (32ZD08G)
RG26	24366229	CF, 2.2 ohm (32ZD08G)
RG75	24552182	OMF, 1800 ohm, 1/2W (32ZD08G)
RR01	24366102	CF, 1k ohm
RR02	24366104	CF, 100k ohm
RR03	24366222	CF, 2200 ohm
RR04	24366101	CF, 100 ohm
RR05	24366102	CF, 1k ohm
RR06	24366223	CF, 22k ohm

Location No.	Part No.	Description
RR07	24366152	CF, 1500 ohm
RR10	24366102	CF, 1k ohm
RR11	24366681	CF, 680 ohm
RR12	24366152	CF, 1500 ohm
RR13	24366152	CF, 1500 ohm
RR15	24366391	CF, 390 ohm
RR16	24366391	CF, 390 ohm
RR17	24366391	CF, 390 ohm
RR18	24366102	CF, 1k ohm
RR20	24872103	Chip, 10k ohm, 1/16W
RR22	24366103	CF, 10k ohm
RR23	24366103	CF, 10k ohm
RR24	24000824	Chip, Jumper, 2125 type
RR25	24872102	Chip, 1k ohm, 1/16W
RR32	24366331	CF, 330 ohm
RR33	24366331	CF, 330 ohm
RR34	24366331	CF, 330 ohm
RR35	24366392	CF, 3900 ohm
RR36	24366392	CF, 3900 ohm
RR37	24366392	CF, 3900 ohm
RR40	24366102	CF, 1k ohm
RR48	24366102	CF, 1k ohm
RR74	24366102	CF, 1k ohm
RR75	24366102	CF, 1k ohm
RR76	24366181	CF, 180 ohm
RR77	24366181	CF, 180 ohm
RR78	24366181	CF, 180 ohm
RS01	24872681	Chip, 680 ohm, 1/16W
RS02	24872681	Chip, 680 ohm, 1/16W
RS03	24872562	Chip, 5600 ohm, 1/16W
RS04	24872562	Chip, 5600 ohm, 1/16W
RS05	24872562	Chip, 5600 ohm, 1/16W
RS06	24872562	Chip, 5600 ohm, 1/16W
RS07	24872562	Chip, 5600 ohm, 1/16W
RS08	24872562	Chip, 5600 ohm, 1/16W
RS09	24872562	Chip, 5600 ohm, 1/16W
RS10	24872562	Chip, 5600 ohm, 1/16W
RS13	24872101	Chip, 100 ohm, 1/16W
RS14	24872101	Chip, 100 ohm, 1/16W
RS15	24872104	Chip, 100k ohm, 1/16W
RS16	24872104	Chip, 100k ohm, 1/16W
RS17	24872223	Chip, 22k ohm, 1/16W
RS18	24872223	Chip, 22k ohm, 1/16W
RS19	24872681	Chip, 680 ohm, 1/16W
RS20	24872681	Chip, 680 ohm, 1/16W
RS21	24872222	Chip, 2200 ohm, 1/16W
RS22	24872222	Chip, 2200 ohm, 1/16W
RS23	24872101	Chip, 100 ohm, 1/16W
RS24	24872101	Chip, 100 ohm, 1/16W
RS27	24872104	Chip, 100k ohm, 1/16W
RS28	24872104	Chip, 100k ohm, 1/16W
RS29	24872223	Chip, 22k ohm, 1/16W
RS30	24872223	Chip, 22k ohm, 1/16W
RS31	24872103	Chip, 10k ohm, 1/16W
RS32	24872104	Chip, 100k ohm, 1/16W
RS35	24872223	Chip, 22k ohm, 1/16W
RS36	24872223	Chip, 22k ohm, 1/16W
RS37	24872104	Chip, 100k ohm, 1/16W
RS38	24872104	Chip, 100k ohm, 1/16W
RS43	24872681	Chip, 680 ohm, 1/16W
RS44	24872681	Chip, 680 ohm, 1/16W
RV05	24872101	Chip, 100 ohm, 1/16W
RV06	24872152	Chip, 1500 ohm, 1/16W
RV07	24872103	Chip, 10k ohm, 1/16W



Location No.	Part No.	Description
RV08	24872103	Chip, 10k ohm, 1/16W
RV09	24872101	Chip, 100 ohm, 1/16W
RV10	24872101	Chip, 100 ohm, 1/16W
RV12	24872681	Chip, 680 ohm, 1/16W
RV13	24872681	Chip, 680 ohm, 1/16W
RV22	24366222	CF, 2200 ohm
RV23	24552101	OMF, 100 ohm, 1/2W
RV24	24366181	CF, 180 ohm
RV25	24872101	Chip, 100 ohm, 1/16W
RV26	24366181	CF, 180 ohm
RV27	24872750	Chip, 75 ohm, 1/16W
RV28	24872562	Chip, 5600 ohm, 1/16W
RV29	24872103	Chip, 10k ohm, 1/16W
RV30	24872750	Chip, 75 ohm, 1/16W
RV31	24872750	Chip, 75 ohm, 1/16W
RV32	24872750	Chip, 75 ohm, 1/16W
RV33	24872562	Chip, 5600 ohm, 1/16W
RV34	24872562	Chip, 5600 ohm, 1/16W
RV37	24872750	Chip, 75 ohm, 1/16W
RV60	24872102	Chip, 1k ohm, 1/16W
RV61	24552101	OMF, 100 ohm, 1/2W
RV62	24872101	Chip, 100 ohm, 1/16W
RV63	24366151	CF, 150 ohm
RV64	24872750	Chip, 75 ohm, 1/16W
RV65	24552101	OMF, 100 ohm, 1/2W
RV66	24872750	Chip, 75 ohm, 1/16W
RV67	24366151	CF, 150 ohm
RV68	24872101	Chip, 100 ohm, 1/16W
RV70	24872101	Chip, 100 ohm, 1/16W
RV71	24872472	Chip, 4700 ohm, 1/16W
RV80	24366681	CF, 680 ohm
RV81	24872750	Chip, 75 ohm, 1/16W
RV82	24872101	Chip, 100 ohm, 1/16W
RV83	24366681	CF, 680 ohm
RV85	24872750	Chip, 75 ohm, 1/16W
RV86	24872750	Chip, 75 ohm, 1/16W
RV87	24872750	Chip, 75 ohm, 1/16W
RV89	24872750	Chip, 75 ohm, 1/16W
RV90	24872681	Chip, 680 ohm, 1/16W
RV91	24872681	Chip, 680 ohm, 1/16W
RV95	24872750	Chip, 75 ohm, 1/16W
RV96	24872750	Chip, 75 ohm, 1/16W
RV97	24872750	Chip, 75 ohm, 1/16W
RX101	24872393	Chip, 39k ohm, 1/16W
RX102	24872153	Chip, 15k ohm, 1/16W
RX103	24872221	Chip, 220 ohm, 1/16W
RX104	24872392	Chip, 3900 ohm, 1/16W
RX106	24872331	Chip, 330 ohm, 1/16W
RX107	24872821	Chip, 820 ohm, 1/16W
RX108	24872680	Chip, 68 ohm, 1/16W
RX109	24872122	Chip, 1200 ohm, 1/16W
RX110	24872122	Chip, 1200 ohm, 1/16W
RX111	24872681	Chip, 680 ohm, 1/16W
RX112	24872470	Chip, 47 ohm, 1/16W
RX113	24872471	Chip, 470 ohm, 1/16W
RX114	24872681	Chip, 680 ohm, 1/16W
RX115	24872101	Chip, 100 ohm, 1/16W
RX116	24872681	Chip, 680 ohm, 1/16W
RX117	24872201	Chip, 200 ohm, 1/16W
RX118	24872221	Chip, 220 ohm, 1/16W
RX119	24872101	Chip, 100 ohm, 1/16W
RX120	24872101	Chip, 100 ohm, 1/16W
RX121	24872101	Chip, 100 ohm, 1/16W
RX122	24872122	Chip, 1200 ohm, 1/16W

Location No.	Part No.	Description
RX123	24872331	Chip, 330 ohm, 1/16W
RX124	24872101	Chip, 100 ohm, 1/16W
RX125	24872101	Chip, 100 ohm, 1/16W
RX130	24872561	Chip, 560 ohm, 1/16W
RX131	24872102	Chip, 1k ohm, 1/16W
RX141	24872101	Chip, 100 ohm, 1/16W
RX143	24872393	Chip, 39k ohm, 1/16W
RX144	24872153	Chip, 15k ohm, 1/16W
RX145	24872201	Chip, 200 ohm, 1/16W
RX146	24872221	Chip, 220 ohm, 1/16W
RX147	24872681	Chip, 680 ohm, 1/16W
RX150	24872101	Chip, 100 ohm, 1/16W
RX152	24872331	Chip, 330 ohm, 1/16W
RX155	24872102	Chip, 1k ohm, 1/16W
RX156	24872272	Chip, 2700 ohm, 1/16W
RX157	24872471	Chip, 470 ohm, 1/16W
RX158	24872471	Chip, 470 ohm, 1/16W
RX161	24872101	Chip, 100 ohm, 1/16W
RX163	24872393	Chip, 39k ohm, 1/16W
RX164	24872153	Chip, 15k ohm, 1/16W
RX165	24872201	Chip, 200 ohm, 1/16W
RX166	24872221	Chip, 220 ohm, 1/16W
RX167	24872681	Chip, 680 ohm, 1/16W
RX170	24872101	Chip, 100 ohm, 1/16W
RX172	24872331	Chip, 330 ohm, 1/16W
RX175	24872102	Chip, 1k ohm, 1/16W
RX176	24872272	Chip, 2700 ohm, 1/16W
RX177	24872471	Chip, 470 ohm, 1/16W
RX178	24872471	Chip, 470 ohm, 1/16W
RX179	24872101	Chip, 100 ohm, 1/16W
RX180	24872101	Chip, 100 ohm, 1/16W
RX181	24872680	Chip, 68 ohm, 1/16W
RX185	24872470	Chip, 47 ohm, 1/16W
RX186	24872101	Chip, 100 ohm, 1/16W
RX191	24872100	Chip, 10 ohm, 1/16W
RX192	24872100	Chip, 10 ohm, 1/16W
RX193	24872100	Chip, 10 ohm, 1/16W
RX201	24872102	Chip, 1k ohm, 1/16W
RX202	24872103	Chip, 10k ohm, 1/16W
RX203	24872103	Chip, 10k ohm, 1/16W
RX204	24000824	Chip, Jumper, 2125 type
RX205	24019439	Chip, 47 ohm, 1/16W
RX206	24019439	Chip, 47 ohm, 1/16W
RX207	24019439	Chip, 47 ohm, 1/16W
RX208	24019439	Chip, 47 ohm, 1/16W
RX209	24019439	Chip, 47 ohm, 1/16W
RX210	24019439	Chip, 47 ohm, 1/16W
RX211	24019439	Chip, 47 ohm, 1/16W
RX212	24019439	Chip, 47 ohm, 1/16W
RX214	24872103	Chip, 10k ohm, 1/16W
RX216	24872102	Chip, 1k ohm, 1/16W
RX221	24872470	Chip, 47 ohm, 1/16W
RX222	24872470	Chip, 47 ohm, 1/16W
RX223	24872470	Chip, 47 ohm, 1/16W
RX225	24872151	Chip, 150 ohm, 1/16W
RX226	24872331	Chip, 330 ohm, 1/16W
RX229	24872332	Chip, 3300 ohm, 1/16W
RX231	24872470	Chip, 47 ohm, 1/16W
RX232	24872470	Chip, 47 ohm, 1/16W
RX233	24872470	Chip, 47 ohm, 1/16W
RX235	24872274	Chip, 270k ohm, 1/16W
RX236	24872472	Chip, 4700 ohm, 1/16W
RX237	24872221	Chip, 220 ohm, 1/16W
RX240	24872272	Chip, 2700 ohm, 1/16W

Location No.	Part No.	Description
RX256	24000824	Chip, Jumper, 2125 type
RX258	24872470	Chip, 47 ohm, 1/16W
RX259	24872470	Chip, 47 ohm, 1/16W
RX261	24872101	Chip, 100 ohm, 1/16W
RX263	24872101	Chip, 100 ohm, 1/16W
RX274	24872221	Chip, 220 ohm, 1/16W
RX275	24872221	Chip, 220 ohm, 1/16W
RX276	24872221	Chip, 220 ohm, 1/16W
RX277	24872221	Chip, 220 ohm, 1/16W
RX278	24872221	Chip, 220 ohm, 1/16W
RX279	24872471	Chip, 470 ohm, 1/16W
RX280	24872471	Chip, 470 ohm, 1/16W
RX281	24019439	Chip, 47 ohm, 1/16W
RX282	24019439	Chip, 47 ohm, 1/16W
RX283	24019439	Chip, 47 ohm, 1/16W
RX284	24019439	Chip, 47 ohm, 1/16W
RX285	24872332	Chip, 3300 ohm, 1/16W
RX286	24872332	Chip, 3300 ohm, 1/16W
RX291	24872101	Chip, 100 ohm, 1/16W
RX292	24872101	Chip, 100 ohm, 1/16W
RX293	24872332	Chip, 3300 ohm, 1/16W
RX301	24872201	Chip, 200 ohm, 1/16W
RX302	24872272	Chip, 2700 ohm, 1/16W
RX303	24872201	Chip, 200 ohm, 1/16W
RX304	24872272	Chip, 2700 ohm, 1/16W
RX305	24872201	Chip, 200 ohm, 1/16W
RX306	24872272	Chip, 2700 ohm, 1/16W
RX307	24872472	Chip, 4700 ohm, 1/16W
RX308	24872222	Chip, 2200 ohm, 1/16W
RX309	24872122	Chip, 1200 ohm, 1/16W
RX310	24872122	Chip, 1200 ohm, 1/16W
RX311	24872122	Chip, 1200 ohm, 1/16W
RX312	24872101	Chip, 100 ohm, 1/16W
RX313	24872152	Chip, 1500 ohm, 1/16W
RX314	24872101	Chip, 100 ohm, 1/16W
RX315	24872101	Chip, 100 ohm, 1/16W
RX316	24872101	Chip, 100 ohm, 1/16W
RX321	24872223	Chip, 22k ohm, 1/16W
RX322	24872223	Chip, 22k ohm, 1/16W
RX325	24872101	Chip, 100 ohm, 1/16W
RX330	24872821	Chip, 820 ohm, 1/16W
RX331	24872151	Chip, 150 ohm, 1/16W
RX332	24872821	Chip, 820 ohm, 1/16W
RX334	24872561	Chip, 560 ohm, 1/16W
RX341	24872223	Chip, 22k ohm, 1/16W
RX342	24872223	Chip, 22k ohm, 1/16W
RX345	24872101	Chip, 100 ohm, 1/16W
RX350	24872821	Chip, 820 ohm, 1/16W
RX351	24872121	Chip, 120 ohm, 1/16W
RX352	24872681	Chip, 680 ohm, 1/16W
RX354	24872561	Chip, 560 ohm, 1/16W
RX361	24872223	Chip, 22k ohm, 1/16W
RX362	24872223	Chip, 22k ohm, 1/16W
RX365	24872101	Chip, 100 ohm, 1/16W
RX370	24872821	Chip, 820 ohm, 1/16W
RX371	24872121	Chip, 120 ohm, 1/16W
RX372	24872681	Chip, 680 ohm, 1/16W
RX374	24872561	Chip, 560 ohm, 1/16W
RX402	24872101	Chip, 100 ohm, 1/16W
RX404	24872101	Chip, 100 ohm, 1/16W
RX406	24872101	Chip, 100 ohm, 1/16W
RX408	24872101	Chip, 100 ohm, 1/16W
RX410	24872101	Chip, 100 ohm, 1/16W
RX412	24872101	Chip, 100 ohm, 1/16W

Location No.	Part No.	Description
RX421	24872221	Chip, 220 ohm, 1/16W
RX422	24872221	Chip, 220 ohm, 1/16W
RX423	24872221	Chip, 220 ohm, 1/16W
RX424	24872221	Chip, 220 ohm, 1/16W
RX425	24872221	Chip, 220 ohm, 1/16W
RX427	24872221	Chip, 220 ohm, 1/16W
RX428	24872221	Chip, 220 ohm, 1/16W
RX429	24872221	Chip, 220 ohm, 1/16W
RX430	24872221	Chip, 220 ohm, 1/16W
RX431	24322478	MF, 0.47 ohm, 1W
RZ01	24872102	Chip, 1k ohm, 1/16W
RZ02	24872102	Chip, 1k ohm, 1/16W
RZ03	24872332	Chip, 3300 ohm, 1/16W
RZ04	24872102	Chip, 1k ohm, 1/16W
RZ05	24872391	Chip, 390 ohm, 1/16W
RZ06	24872821	Chip, 820 ohm, 1/16W
RZ08	24872391	Chip, 390 ohm, 1/16W
RZ09	24872101	Chip, 100 ohm, 1/16W
RZ13	24872102	Chip, 1k ohm, 1/16W
RZ14	24872102	Chip, 1k ohm, 1/16W
RZ15	24872102	Chip, 1k ohm, 1/16W
RZ17	24872391	Chip, 390 ohm, 1/16W
RZ18	24872391	Chip, 390 ohm, 1/16W
RZ20	24872101	Chip, 100 ohm, 1/16W
RZ29	24872101	Chip, 100 ohm, 1/16W
RZ30	24872101	Chip, 100 ohm, 1/16W

**COILS & TRANSFORMERS**

L101	23221803	Coil, Choke, TLN3040D
L201	23289840	Coil, Peaking, TRF4100AT
L301	23103859	Coil (Ferrite Bead), TEM2011
L302	23289846	Coil, Peaking, TRF4101AT
L400	23289840	Coil, Peaking, TRF4100AT
L400	23289846	Coil, Peaking, TRF4101AT
L410	23103859	Coil (Ferrite Bead), TEM2011
L441	23233983	Coil, Linearity, TLN2199AG
L442	23248216	Coil, Choke, TLN3459AH
L449	23103859	Coil (Ferrite Bead), TEM2011
L461	23248183	Coil, Choke, TLN3343AD
L470	23103859	Coil (Ferrite Bead), TEM2011
L491	23211923	Coil, Choke, AT4043/100
L501	23238714	Coil, Peaking, TRF4100AJ
L501	23289840	Coil, Peaking, TRF4100AT
L503	23289840	Coil, Peaking, TRF4100AT
L503	23289844	Coil, Peaking, TRF4470AT
L510	23103852	Coil, Filter, TEM2028AH
L511	23103852	Coil, Filter, TEM2028AH
L512	23103898	Coil, Filter, TEM2030AH
L513	23103898	Coil, Filter, TEM2030AH
L513	23103898	Coil, Filter, TEM2030AH
L515	23103898	Coil, Filter, TEM2030AH
L605	23248073	Coil, Choke, TLN3299D
L631	23103832	Chip (Ferrite Bead), TEM2125M
L632	24000824	Chip Jumper, 2125 Type
L676	23103832	Chip (Ferrite Bead), TEM2125M
L677	23103832	Chip (Ferrite Bead), TEM2125M
L682	23103832	Chip (Ferrite Bead), TEM2125M
L683	23103832	Chip (Ferrite Bead), TEM2125M
L684	23289834	Coil, Peaking, TRF41R0AT

Location No.	Part No.	Description
L685	23289834	Coil, Peaking, TRF41R0AT
L701	23289840	Coil, Peaking, TRF4100AT
L702	23261974	Coil, Choke, HC5-035
L704	23103859	Coil (Ferrite Bead), TEM2011
L705	23103859	Coil (Ferrite Bead), TEM2011
L811	23103859	Coil (Ferrite Bead), TEM2011
L876	23280016	Coil, Peaking, TRF4100AZ
L883	23221747	Coil, Choke, TRF9253D
L885	23248073	Coil, Choke, TLN3299D
L886	23103859	Coil (Ferrite Bead), TEM2011
L889	23222694	Coil, Width, TLN2026
L891	23103859	Coil (Ferrite Bead), TEM2011
L892	23103859	Coil (Ferrite Bead), TEM2011
L893	23280016	Coil, Peaking, TRF4100AZ
L894	23289840	Coil, Peaking, TRF4100AT
L895	23222694	Coil, Width, TLN2026
L896	23103859	Coil (Ferrite Bead), TEM2011
L897	23222694	Coil, Width, TLN2026
△L901	23200404	Coil, Degaussing, TSB-2395AM
L902	23289846	Coil, Peaking, TRF4101AT
L903	23289846	Coil, Peaking, TRF4101AT
L904	23289846	Coil, Peaking, TRF4101AT
L905	23289841	Coil, Peaking, TRF4150AT
L906	23289841	Coil, Peaking, TRF4150AT
L907	23289841	Coil, Peaking, TRF4150AT
L908	23289840	Coil, Peaking, TRF4100AT
L910	23289834	Coil, Peaking, TRF41R0AT
LA01	23289840	Coil, Peaking, TRF4100AT
LC30	23103775	Coil (Ferrite Bead), TEM2014
LC31	23103775	Coil (Ferrite Bead), TEM2014
LC43	23103775	Coil (Ferrite Bead), TEM2014
LC44	23103775	Coil (Ferrite Bead), TEM2014
LC45	23289834	Coil, Peaking, TRF41R0AT
LC88	23289834	Coil, Peaking, TRF41R0AT
LD87	23103832	Chip (Ferrite Bead), TEM2125M
LD89	23289844	Coil, Peaking, TRF4470AT
LF01	23289840	Coil, Peaking, TRF4100AT (3ZZD08G)
LF01	23103775	Coil (Ferrite Bead), TEM2014 (3ZZD08B)
LF02	23289834	Coil, Peaking, TRF41R0AT (3ZZD08G)
LF02	24366100	CF, 10 ohm (3ZZD08B)
LF03	24366100	CF, 10 ohm (3ZZD08B)
LF04	24366100	CF, 10 ohm (3ZZD08B)
LF06	23238562	Coil, Peaking, TRF4109AJ (3ZZD08B)
LF07	23238562	Coil, Peaking, TRF4109AJ (3ZZD08B)
LF08	23238714	Coil, Peaking, TRF4100AJ (3ZZD08B)
LF09	23238714	Coil, Peaking, TRF4100AJ (3ZZD08B)
LF10	23289840	Coil, Peaking, TRF4100AT (3ZZD08G)
LF10	23238562	Coil, Peaking, TRF4109AJ (3ZZD08B)
LF11	23289834	Coil, Peaking, TRF41R0AT (3ZZD08B)
LF12	23289840	Coil, Peaking, TRF4100AT (3ZZD08B)
LF13	23289840	Coil, Peaking, TRF4100AT (3ZZD08B)

Location No.	Part No.	Description
LF17	23289840	Coil, Peaking, TRF4100AT (3ZZD08B)
LF21	23238714	Coil, Peaking, TRF4100AJ (3ZZD08G)
LF22	23238562	Coil, Peaking, TRF4109AJ (3ZZD08G)
LF23	23238562	Coil, Peaking, TRF4109AJ (3ZZD08G)
LF24	23238562	Coil, Peaking, TRF4109AJ (3ZZD08G)
LF25	23238506	Coil, Peaking, TRF4229AJ (3ZZD08G)
LF26	23238506	Coil, Peaking, TRF4229AJ (3ZZD08G)
LF27	23238506	Coil, Peaking, TRF4229AJ (3ZZD08G)
LF28	23238506	Coil, Peaking, TRF4229AJ (3ZZD08G)
LF29	23238714	Coil, Peaking, TRF4100AJ (3ZZD08G)
LF30	23238714	Coil, Peaking, TRF4100AJ (3ZZD08G)
LF31	23289840	Coil, Peaking, TRF4100AT (3ZZD08G)
LF50	23238714	Coil, Peaking, TRF4100AJ (3ZZD08G)
LG03	23103859	Coil (Ferrite Bead), TEM2011 (3ZZD08G)
LG08	23103859	Coil (Ferrite Bead), TEM2011 (3ZZD08G)
LG10	23103859	Coil (Ferrite Bead), TEM2011 (3ZZD08G)
LG11	23103859	Coil (Ferrite Bead), TEM2011 (3ZZD08G)
LG24	23280016	Coil, Peaking, TRF4100AZ (3ZZD08G)
LG25	23289840	Coil, Peaking, TRF4100AT (3ZZD08G)
LR01	23289834	Coil, Peaking, TRF41R0AT
LR02	23289834	Coil, Peaking, TRF41R0AT
LR26	23103898	Coil, Filter, TEM2030AH
LS45	23103832	Chip (Ferrite Bead), TEM2125M
LS46	23103832	Chip (Ferrite Bead), TEM2125M
LV01	23103852	Coil, Filter, TEM2028AH
LV02	23103898	Coil, Filter, TEM2030AH
LV03	23103852	Coil, Filter, TEM2028AH
LV06	23103832	Chip (Ferrite Bead), TEM2125M
LV07	23103832	Chip (Ferrite Bead), TEM2125M
LV09	23289840	Coil, Peaking, TRF4100AT
LV10	23103852	Coil, Filter, TEM2028AH
LV11	23103852	Coil, Filter, TEM2028AH
LV20	23103898	Coil, Filter, TEM2030AH
LV42	23289840	Coil, Peaking, TRF4100AT
LV43	23289840	Coil, Peaking, TRF4100AT
LV49	23103852	Coil, Filter, TEM2028AH
LX101	23103822	Chip (Ferrite Bead), TEM2117T
LX104	23245827	Chip, Inductor, TRF45R6CB
LX105	23103822	Chip (Ferrite Bead), TEM2117T
LX106	23103822	Chip (Ferrite Bead), TEM2117T
LX107	23103822	Chip (Ferrite Bead), TEM2117T

Location No.	Part No.	Description
LX110	23103822	Chip (Ferrite Bead), TEM2117T
LX143	23245835	Chip, Inductor, TRF4270CB
LX144	23103822	Chip (Ferrite Bead), TEM2117T
LX145	23103822	Chip (Ferrite Bead), TEM2117T
LX150	23103822	Chip (Ferrite Bead), TEM2117T
LX152	23103822	Chip (Ferrite Bead), TEM2117T
LX153	23103822	Chip (Ferrite Bead), TEM2117T
LX163	23245835	Chip, Inductor, TRF4270CB
LX201	23103886	Chip (Ferrite Bead), TEM2129AM
LX221	23103822	Chip (Ferrite Bead), TEM2117T
LX222	23103822	Chip (Ferrite Bead), TEM2117T
LX223	23103822	Chip (Ferrite Bead), TEM2117T
LX226	23103822	Chip (Ferrite Bead), TEM2117T
LX227	23103822	Chip (Ferrite Bead), TEM2117T
LX231	23103822	Chip (Ferrite Bead), TEM2117T
LX232	23103822	Chip (Ferrite Bead), TEM2117T
LX233	23103822	Chip (Ferrite Bead), TEM2117T
LX236	23103822	Chip (Ferrite Bead), TEM2117T
LX237	23103822	Chip (Ferrite Bead), TEM2117T
LX241	23103822	Chip (Ferrite Bead), TEM2117T
LX261	23103822	Chip (Ferrite Bead), TEM2117T
LX271	23103822	Chip (Ferrite Bead), TEM2117T
LX301	23103822	Chip (Ferrite Bead), TEM2117T
LX321	23103822	Chip (Ferrite Bead), TEM2117T
LX322	23245825	Chip, Inductor, TRF43R9CB
LX342	23245826	Chip, Inductor, TRF44R7CB
LX362	23245826	Chip, Inductor, TRF44R7CB
LX401	23103886	Chip (Ferrite Bead), TEM2129AM
LX402	23103822	Chip (Ferrite Bead), TEM2117T
LX403	23103822	Chip (Ferrite Bead), TEM2117T
LX404	23103822	Chip (Ferrite Bead), TEM2117T
LX405	23103822	Chip (Ferrite Bead), TEM2117T
LX407	23103822	Chip (Ferrite Bead), TEM2117T
LX421	23238562	Coil, Peaking, TRF4109AJ
LX422	23238562	Coil, Peaking, TRF4109AJ
LX423	23238562	Coil, Peaking, TRF4109AJ
LX424	23238562	Coil, Peaking, TRF4109AJ
LX425	23238562	Coil, Peaking, TRF4109AJ
LX427	23238562	Coil, Peaking, TRF4109AJ
LX428	23238718	Coil, Peaking, TRF4479AJ
LX429	23238718	Coil, Peaking, TRF4479AJ
LX430	23238562	Coil, Peaking, TRF4109AJ
LX431	23103880	Coil (Ferrite Bead), TEM2011Y
LZ01	23238710	Coil, Peaking, TRF4220AJ
LZ02	23238714	Coil, Peaking, TRF4100AJ
LZ03	23238714	Coil, Peaking, TRF4100AJ
LZ04	23238708	Coil, Peaking, TRF4330AJ
LZ05	23238709	Coil, Peaking, TRF4270AJ
LZ06	23103852	Coil, Filter, TEM2028AH
LZ07	70131060	Baze Filter, ZBF253D-00
LZ08	23238707	Coil, Peaking, TRF4390AJ
LZ09	70131060	Baze Filter, ZBF253D-00
LZ10	70131060	Baze Filter, ZBF253D-00
△ T400	23224364	Transformer, Focus, TLN2168AH
T401	23224371	Transformer, Horiz, Drive, TLN1080AH
△ T461	23236625	Transformer, Flyback, TFB4162AD
T461D	23236447	ANODE4115B
△ TG01	23217466	Transformer, Converter, TPW3449AM (3ZD08G)

Location No.	Part No.	Description
△ T863	23217434	Transformer, Converter, TPW3427AG
<b>SEMICONDUCTORS</b>		
Q200	A6330059	Transistor, 2SC2482(C)
Q201	A6317440	Transistor, 2SC1815-Y
Q202	A6534040	Transistor, 2SA1015-Y
Q203	A6534040	Transistor, 2SA1015-Y
Q204	A6534040	Transistor, 2SA1015-Y
Q205	A6534040	Transistor, 2SA1015-Y
Q206	A6317440	Transistor, 2SC1815-Y
Q209	A6534040	Transistor, 2SA1015-Y
Q237	A6317440	Transistor, 2SC1815-Y
Q261	A6534040	Transistor, 2SA1015-Y
Q262	A6317440	Transistor, 2SC1815-Y
Q263	A6317440	Transistor, 2SC1815-Y
Q274	A6335470	Transistor, 2SC2712-Y
Q301	23905610	IC, LA7846N
Q301B	70391355	Screw, BITTB3X8 SZN
Q303	A6534040	Transistor, 2SA1015-Y
Q304	A6317440	Transistor, 2SC1815-Y
Q370	A6002020	Transistor, RN1202
Q370	A6534040	Transistor, 2SA1015-Y
Q371	A6002020	Transistor, RN1202
Q390	23905953	IC, MC7812BT
Q390B	70391355	Screw, BITTB3X8 SZN
Q391	23319247	IC, MC7912CT
Q391B	70391355	Screw, BITTB3X8 SZN
Q402	A6325413	Transistor, 2SC2235-O
Q404	A6374144	Transistor, 2CS5570
Q404B	A8012650	Spacer, AC263
Q404D	72471082	Screw, BRDT2W3X10 SZN
Q418	23314141	Transistor, 2SC3852
Q418B	70391355	Screw, BITTB3X8 SZN
Q420	23314141	Transistor, 2SC3852
Q420B	70391355	Screw, BITTB3X8 SZN
Q421	A6317440	Transistor, 2SC1815-Y
Q425	A6317440	Transistor, 2SC1815-Y
Q426	A6002060	Transistor, RN1206
Q427	A6002060	Transistor, RN1206
Q428	A6002060	Transistor, RN1206
Q430	23314141	Transistor, 2SC3852
Q430B	70391355	Screw, BITTB3X8 SZN
Q432	23114433	Transistor, 2SC1815-Y (3ZD08B)
Q460	23314850	Transistor, 2SA1788, E
Q460B	72471082	Screw, BRDT2W3X10 SZN
Q461	A6317440	Transistor, 2SC1815-Y
Q462	A6317440	Transistor, 2SC1815-Y
Q470	A6317440	Transistor, 2SC1815-Y
Q470	A6547250	Transistor, 2SA1320
Q471	A6317440	Transistor, 2SC1815-Y
Q472	A6317440	Transistor, 2SC1815-Y
Q473	A6534040	Transistor, 2SA1015-Y
Q504	A6541130	Transistor, 2SA1162-Y
Q505	A6541130	Transistor, 2SA1162-Y
Q506	A6317440	Transistor, 2SC1815-Y
Q507	A6361770	Transistor, 2SC3437-Y
Q510	B0386208	IC, TA1276AN
Q608	A6534040	Transistor, 2SA1015-Y
Q612	A6534040	Transistor, 2SA1015-Y
Q620	23906596	IC, BA4558
Q631	23906596	IC, BA4558
Q632	A6014040	Transistor, RN2404

Location No.	Part No.	Description
Q633	A6359870	Transistor, 2SC3326-B
Q634	A6014040	Transistor, RN2404
Q635	A6359870	Transistor, 2SC3326-B
Q639	A6342200	Transistor, 2CS2878-A
Q640	B0377308	IC, TA8256BH
Q640B	70391355	Screw, BITTB3X8 SZN
Q641	A6342200	Transistor, 2CS2878-A
Q642	A6342200	Transistor, 2CS2878-A
Q670	B0376856	IC, TA8211AH
Q670B	70391355	Screw, BITTB3X8 SZN
Q671	A6342200	Transistor, 2CS2878-A
Q672	A6342200	Transistor, 2CS2878-A
Q688	A6002040	Transistor, RN1204
Q705	A6317440	Transistor, 2SC1815-Y
Q706	A6317440	Transistor, 2SC1815-Y
Q707	A6734590	Transistor, 2SC752(G)TM-Y
Q709	A6317440	Transistor, 2SC1815-Y
Q710	A6534040	Transistor, 2SA1015-Y
Q711	23314911	Transistor, 2SB1569A E
Q711B	70391355	Screw, BITTB3X8 SZN
Q712	23314914	Transistor, 2SD2400A E
Q712B	70391355	Screw, BITTB3X8 SZN
Q719	A6317440	Transistor, 2SC1815-Y
Q801	23135008	IC, STR-F6668B
Q801B	72471082	Screw, BRDT2W3X10 SZN
Q802	23314141	Transistor, 2SC3852
Q802B	70391355	Screw, BITTB3X8 SZN
Q805	A6314440	Transistor, 2SC1627-Y (3ZD08G)
Q805	23114433	Transistor, 2SC1815-Y (3ZD08B)
Q807	A6317440	Transistor, 2SC1815-Y (3ZD08G)
△Q826	A8643108	Photo Coupler, TLP621(GR-LF
Q827	23319693	IC, SE116N, LF4
Q830	23314141	Transistor, 2SC3852
Q830B	70391355	Screw, BITTB3X8 SZN
Q831	23314141	Transistor, 2SC3852
Q831B	70391355	Screw, BITTB3X8 SZN
Q832	23905977	IC, PQ09RD11
Q832B	70391355	Screw, BITTB3X8 SZN
Q833	23314141	Transistor, 2SC3852
Q833B	70391355	Screw, BITTB3X8 SZN
Q840	23318299	IC, L78MR05
Q840B	70391355	Screw, BITTB3X8 SZN
Q841	23114433	Transistor, 2SC1815-Y (3ZD08B)
Q842	23114433	Transistor, 2SC1815-Y (3ZD08B)
Q901	A6368700	Transistor, 2CS4544
Q901B	70391355	Screw, BITTB3X8 SZN
Q902	A6317440	Transistor, 2SC1815-Y
Q903	A6368700	Transistor, 2CS4544
Q903B	70391355	Screw, BITTB3X8 SZN
Q904	A6317440	Transistor, 2SC1815-Y
Q905	A6368700	Transistor, 2CS4544
Q905B	70391355	Screw, BITTB3X8 SZN
Q906	A6317440	Transistor, 2SC1815-Y
Q907	A6509140	Transistor, 2SA562TM-Y
Q908	A6321240	Transistor, 2SC2120-Y
Q910	A6317440	Transistor, 2SC1815-Y
Q911	A6317440	Transistor, 2SC1815-Y
Q912	A6534040	Transistor, 2SA1015-Y
Q913	A6534040	Transistor, 2SA1015-Y

Location No.	Part No.	Description
Q914	A6317440	Transistor, 2SC1815-Y
Q4420	B01A0067	IC, TA1300AN
Q4462	A6317440	Transistor, 2SC1815-Y
Q4490	A8641063	Photo Coupler, TLP521-1
Q4491	23314917	Transistor, 2SK2003-01MR
Q4493	A6317440	Transistor, 2SC1815-Y
QA01	23000526	IC, 750010-132S(3ZD08G)
QA01	23000537	IC, CXP750010-134S(3ZD08B)
QA02	23906642	IC, AT24C64-10PC
QA05	A6734590	Transistor, 2SC752(G)TM-Y
QA80	A6002020	Transistor, RN1202 (3ZD08G)
QA81	A6002020	Transistor, RN1202 (3ZD08G)
QA82	23904943	IC, MM1111XS (3ZD08G)
QA83	A6002040	Transistor, RN1204 (3ZD08G)
QB01	A6534040	Transistor, 2SA1015-Y
QB03	A6002050	Transistor, RN1205
QB03	A6534040	Transistor, 2SA1015-Y
QB04	A6534040	Transistor, 2SA1015-Y
QB30	A6317440	Transistor, 2SC1815-Y
QB81	A6342200	Transistor, 2CS2878-A
QB82	A6342200	Transistor, 2CS2878-A
QB83	A6534040	Transistor, 2SA1015-Y
QB92	A6317440	Transistor, 2SC1815-Y
QB93	A6534040	Transistor, 2SA1015-Y
QB94	A6534040	Transistor, 2SA1015-Y
QB95	A6534040	Transistor, 2SA1015-Y
QB96	A6534040	Transistor, 2SA1015-Y
QD89	A6335470	Transistor, 2SC2712-Y
QF01	23906551	IC, SDA5275-3P (3ZD08G)
QF01	23000507	IC, SDA5275-3S (3ZD08B)
QF02	23906927	IC, SAB-C161RI(3ZD08G)
QF03	23314204	Transistor, 2SC2412K, Q (3ZD08B)
QF04	23000969	IC, MX29F040QC (3ZD08G)
QF04	A6734590	Transistor, 2SC752(G)TM-Y (3ZD08B)
QF05	23000039	IC, AT24C08N10SC(3ZD08G)
QF08	A6541130	Transistor, 2SA1162-Y (3ZD08B)
QF10	23000347	IC, MSM5116400D
QF11	23906367	IC, PST9146NL
QF32	A6361770	Transistor, 2SC3437-Y (3ZD08G)
QF33	A6335470	Transistor, 2SC2712-Y (3ZD08G)
QF34	A6335470	Transistor, 2SC2712-Y (3ZD08G)
QF35	A6335470	Transistor, 2SC2712-Y (3ZD08G)
QF36	A6541130	Transistor, 2SA1162-Y (3ZD08G)
QG01	23135014	IC, STR-G5551(3ZD08G)
QG01B	70391355	Screw, BITTB3X8 SZN
QG36	23314141	Transistor, 2SC3852 (3ZD08G)
QG36B	70391355	Screw, BITTB3X8 SZN
QG37	A6534040	Transistor, 2SA1015-Y (3ZD08G)
QG38	A6317440	Transistor, 2SC1815-Y (3ZD08G)
QR01	23000123	IC, MB90096-192
QR03	23114530	Transistor, 2SA933S-Q
QR24	A6335470	Transistor, 2SC2712-Y
QS01	A6359870	Transistor, 2SC3326-B
QS02	A6359870	Transistor, 2SC3326-B

Location No.	Part No.	Description
QS03	A6335470	Transistor, 2SC2712-Y
QS04	A6335470	Transistor, 2SC2712-Y
QS05	A6359870	Transistor, 2SC3326-B
QS06	A6359870	Transistor, 2SC3326-B
QS07	A6014040	Transistor, RN2404
QS08	A6359870	Transistor, 2SC3326-B
QS09	A6359870	Transistor, 2SC3326-B
QV02	A6317440	Transistor, 2SC1815-Y
QV06	A6541130	Transistor, 2SA1162-Y
QV07	A6335470	Transistor, 2SC2712-Y
QV09	A6317440	Transistor, 2SC1815-Y
QV10	A6335470	Transistor, 2SC2712-Y
QV12	A6317440	Transistor, 2SC1815-Y
QV14	A6317440	Transistor, 2SC1815-Y
QX01	23906921	IC, TC90A61F
QX02	23000198	IC, EM636327Q-8
QX03	23905013	IC, TLC29321PW
QX04	23906951	IC, SN74AHCT1G32
QX05	23906951	IC, SN74AHCT1G32
QX07	23905939	IC, TLC2933IPW
QX08	23906951	IC, SN74AHCT1G32
QX09	23906951	IC, SN74AHCT1G32
QX11	23906318	IC, ADS932E
QX12	23906318	IC, ADS932E
QX15	23314345	Transistor, IMZ1 T108
QX16	23314345	Transistor, IMZ1 T108
QX17	23314345	Transistor, IMZ1 T108
QX18	23314345	Transistor, IMZ1 T108
QX19	A6541130	Transistor, 2SA1162-Y
QX20	A6030670	IC, TC7S66F
QX21	A6030630	IC, TC7S08F
QX22	23314345	Transistor, IMZ1 T108
QX24	23314345	Transistor, IMZ1 T108
QX25	23000197	IC, SN74AHC2G53H
QX26	A6541130	Transistor, 2SA1162-Y
QX27	A6030670	IC, TC7S66F
QX29	23314345	Transistor, IMZ1 T108
QX31	23314345	Transistor, IMZ1 T108
QX33	A6541130	Transistor, 2SA1162-Y
QX34	A6030670	IC, TC7S66F
QX35	23314345	Transistor, IMZ1 T108
QX37	A6335470	Transistor, 2SC2712-Y
QX38	A6335470	Transistor, 2SC2712-Y
QX39	A6335470	Transistor, 2SC2712-Y
QX41	A6335470	Transistor, 2SC2712-Y
QX42	A6335470	Transistor, 2SC2712-Y
QX44	A6335470	Transistor, 2SC2712-Y
QX45	A6335470	Transistor, 2SC2712-Y
QX47	A6335470	Transistor, 2SC2712-Y
QX48	A6335470	Transistor, 2SC2712-Y
QX50	B0485484	IC, TC74HCT541AF
QX51	23906770	IC, BA033FP-E2
QX52	A6030695	IC, TC7SH32FU(BR
QX53	A6030695	IC, TC7SH32FU(BR
QX54	A6004010	Transistor, RN1401
QX55	B0370000	IC, TC78L05F
QX56	A6541130	Transistor, 2SA1162-Y
QX57	A6004010	Transistor, RN1401
QX58	A6004010	Transistor, RN1401
QZ01	B0410895	IC, TC90A49P
QZ02	A6335470	Transistor, 2SC2712-Y
QZ04	A6541130	Transistor, 2SA1162-Y
QZ05	A6541130	Transistor, 2SA1162-Y
QZ07	A6541130	Transistor, 2SA1162-Y

Location No.	Part No.	Description
QZ08	A6335470	Transistor, 2SC2712-Y
D101	23316756	Diode, Zener, MTZJ33D
D201	23115599	Diode, 1N4148
D240	23115599	Diode, 1N4148
D301	23118094	Diode, EU2A, LF-F10
D302	23118094	Diode, EU2A, LF-F10
D304	23118094	Diode, EU2A, LF-F10
D312	23115599	Diode, 1N4148
D313	23115599	Diode, 1N4148
D320	23115599	Diode, 1N4148
D336	23316672	Diode, Zener, MTZJ5.6B
D337	23316672	Diode, Zener, MTZJ5.6B
D370	23118479	Diode, BYD33J
D370	23316658	Diode, Zener, MTZJ3.6A
D371	23115599	Diode, 1N4148
D371	23118479	Diode, BYD33J
D373	23316690	Diode, Zener, MTZJ10B
D374	23115599	Diode, 1N4148
D404	23357043	Diode, FMQ-G5GS
D404B	72471082	Screw, BRDT2W3X10 SZN
D406	23118479	Diode, BYD33J
D415	23118094	Diode, EU2A, LF-F10
D418	23316749	Diode, Zener, MTZJ30A
D419	23316691	Diode, Zener, MTZJ10C
D420	23316715	Diode, Zener, MTZJ11A
D421	23316680	Diode, Zener, MTZJ7.5A
D422	23316726	Diode, Zener, MTZJ15C
D431	23316670	Diode, Zener, MTZJ5.1C
D432	23316670	Diode, Zener, MTZJ5.1C
D436	23115599	Diode, 1N4148
D441	23316687	Diode, Zener, MTZJ9.1B
D460	23118479	Diode, BYD33J
D461	23316803	Diode, FMU-G16S
D461B	70391355	Screw, BITTB3X8 SZN
D463	23115599	Diode, 1N4148
D464	23316718	Diode, Zener, MTZJ12A
D466	23316672	Diode, Zener, MTZJ5.6B
D467	23118479	Diode, BYD33J
D470	23316670	Diode, Zener, MTZJ5.1C
D474	23316719	Diode, Zener, MTZJ12B
D488	23115599	Diode, 1N4148
D490	23115599	Diode, 1N4148
D498	23316745	Diode, Zener, MTZJ27A
D499	23115599	Diode, 1N4148
D501	23115599	Diode, 1N4148
D506	23316673	Diode, Zener, MTZJ5.6C
D507	23357037	Diode, Zener, UdzSTE175.6B
D508	23357037	Diode, Zener, UdzSTE175.6B
D509	23357037	Diode, Zener, UdzSTE175.6B
D511	23357037	Diode, Zener, UdzSTE175.6B
D512	23357037	Diode, Zener, UdzSTE175.6B
D513	23357037	Diode, Zener, UdzSTE175.6B
D611	23115599	Diode, 1N4148
D612	23115599	Diode, 1N4148
D613	23115599	Diode, 1N4148
D614	23115599	Diode, 1N4148
D624	23115599	Diode, 1N4148
D625	23115599	Diode, 1N4148
D626	23115599	Diode, 1N4148
D627	23115599	Diode, 1N4148
D628	23115599	Diode, 1N4148
D630	23115599	Diode, 1N4148
D640	23115599	Diode, 1N4148
D641	23115599	Diode, 1N4148

Location No.	Part No.	Description
D642	23115599	Diode, 1N4148
D643	23115599	Diode, 1N4148
D647	23115599	Diode, 1N4148
D648	23115599	Diode, 1N4148
D670	23115599	Diode, 1N4148
D671	23115599	Diode, 1N4148
D674	23115599	Diode, 1N4148
D675	23115599	Diode, 1N4148
D683	23115599	Diode, 1N4148
D704	23115599	Diode, 1N4148
D705	23115599	Diode, 1N4148
D715	23115599	Diode, 1N4148
D721	23115599	Diode, 1N4148
D801	23357041	Diode, LN6SB60-F05
D804	23316725	Diode, Zener, MTZJ15B
D805	23316553	Diode, 1SS145
D806	23118479	Diode, BYD33J
D810	23316738	Diode, Zener, MTZJ22B
D811	23115599	Diode, 1N4148
D815	23316746	Diode, Zener, MTZJ27B
D817	23115599	Diode, 1N4148
D818	23316738	Diode, Zener, MTZJ22B
D819	23316678	Diode, Zener, MTZJ6.8B
D828	23115599	Diode, 1N4148
D836	23316673	Diode, Zener, MTZJ5.6C
D841	23115599	Diode, 1N4148(32DZ98G)
D842	23316724	Diode, Zener, MTZJ15A
D844	23316717	Diode, Zener, MTZJ11C
D848	23316675	Diode, Zener, MTZJ6.2B (32ZD08B)
D855	23115599	Diode, 1N4148
D871	23118479	Diode, BYD33J
D883	23316406	Diode, FML-G16S
D883B	70391355	Screw, BITTB3X8 SZN
D885	23316642	Diode, YG911S2R
D885B	70391355	Screw, BITTB3X8 SZN
D891	23357020	Diode, SF5S4
D891B	70391355	Screw, BITTB3X8 SZN
D892	23316184	Diode, FML-G12S
D892B	70391355	Screw, BITTB3X8 SZN
D893	23316673	Diode, Zener, MTZJ5.6C
D894	23316673	Diode, Zener, MTZJ5.6C
D896	23118479	Diode, BYD33J
D901	23115599	Diode, 1N4148
D904	23115599	Diode, 1N4148
D905	23115599	Diode, 1N4148
D906	23115599	Diode, 1N4148
D907	23115599	Diode, 1N4148
D908	23115599	Diode, 1N4148
D909	23115599	Diode, 1N4148
D911	23118479	Diode, BYD33J
D912	23115599	Diode, 1N4148
D4222	23316744	Diode, Zener, MTZJ24D
D4223	23115532	Diode, ERB12-01
D4410	23115599	Diode, 1N4148
D4411	23115599	Diode, 1N4148
D4412	23115599	Diode, 1N4148
DA02	23115599	Diode, 1N4148
DA03	23115599	Diode, 1N4148
DA42	23115599	Diode, 1N4148
DB01	23358505	Diode (LED), SLR56VC196F
DB02	23358503	Diode (LED), SCL003MC3FX
DB03	23358503	Diode (LED), SCL003MC3FX
DB04	23358515	Diode (LED), SCL003DC3FXG,

Location No.	Part No.	Description
		Orange
DB30	23115599	Diode, 1N4148
DD89	23118310	Diode, Zener, RD5.6M-T1B2
DF01	23316654	Diode, Zener, MTZJ3.0A
DF02	23115599	Diode, 1N4148 (32DZ98G)
DG02	23316711	Diode, S1WBA60, 4101 (32DZ98G)
DG03	23118479	Diode, BYD33J (32DZ98G)
DG10	23118479	Diode, BYD33J (32DZ98G)
DG11	23316746	Diode, Zener, MTZJ27B (32DZ98G)
DG12	23316672	Diode, Zener, MTZJ5.6B (32DZ98G)
DG13	23316746	Diode, Zener, MTZJ27B (32DZ98G)
DG21	23118479	Diode, BYD33J (32DZ98G)
DG25	23118052	Diode, RU4Z LF-L1 (32DZ98G)
DG27	23316673	Diode, Zener, MTZJ5.6C (32DZ98G)
DR01	23115599	Diode, 1N4148
DR02	23115599	Diode, 1N4148
DR02	23316557	Diode, HSM221C, TL
DR03	23115599	Diode, 1N4148
DR03	23118351	Diode, Zener, RD4.7M-T1BB2
DV01	23115599	Diode, 1N4148
DV14	23118296	Diode, Zener, RD9.1M-T1BB2
<b>ACCESSORIES</b>		
B221	23037312	Screw, BTBW 3X12 SZN
B223	23035412	Screw, BTB 4X12 SZN
B224	23037312	Screw, BTBW 3X12 SZN
BB10	23368627	Plug, 8P
BB10A	23903022	Socket, 8P
BB10B	23903022	Socket, 8P
BB11	23368627	Plug, 8P
BB11A	23903022	Socket, 8P
BB11B	23903022	Socket, 8P
BB12	23368627	Plug, 8P
BB12A	23903022	Socket, 8P
BB12B	23903022	Socket, 8P
BB14	23368627	Plug, 8P
BB14A	23903022	Socket, 8P
BB14B	23903022	Socket, 8P
BB15	23368627	Plug, 8P
BB15A	23903022	Socket, 8P
BB15B	23903022	Socket, 8P
BB16	23368627	Plug, 8P
BB16A	23903022	Socket, 8P
BB16B	23903022	Socket, 8P
△F470	23144503	Fuse, 1.25A, 250V
F470A	23165433	Holder, Fuse
△F801	23144508	Fuse, 4.0A, 250V
F801A	23165433	Holder, Fuse
△F802	23144506	Fuse, 2.5A, 250V
F802A	23165433	Holder, Fuse
F889	23144458	Fuse, 5.0A, 250V
F889A	23165433	Holder, Fuse
G299	24366103	CF, 10k ohm
G306	24366562	CF, 5600 ohm
G312	24366472	CF, 4700 ohm
G337	24366153	CF, 15k ohm
G401	23103859	Coil (Ferrite Bead), TEM2011
G402	23103859	Coil (Ferrite Bead), TEM2011
G403	23103859	Coil (Ferrite Bead), TEM2011

Location No.	Part No.	Description
G404	23103859	Coil (Ferrite Bead), TEM2011
G430	23115532	Diode, ERB12-01E
G465	23316672	Diode, Zener, MTZJ5.6B
G484	24591152	PF, 1500pF
G510	23289838	Coil, Peaking, TRF44R7AT
G527	24567104	PF, 0.1 $\mu$ F
G528	24567104	PF, 0.1 $\mu$ F
G529	24567104	PF, 0.1 $\mu$ F
G638	24366222	CF, 2200 ohm
G684	23115599	Diode, 1N4148
G824	23222694	Coil, Choke, TLN2026
G911	23289846	Coil, Peaking, TRF4101AT
GA82	24085981	EL, 10 $\mu$ F, $\pm$ 20%, 16V, Non-Polar (32ZD08G)
GC09	23261959	Coil, Choke, TRF9240
GC11	23261959	Coil, Choke, TRF9240
GF20	24000824	Chip Jumper, 2125Type (32ZD08G)
GF21	24000824	Chip Jumper, 2125Type (32ZD08G)
GF22	24000824	Chip Jumper, 2125Type (32ZD08G)
GF23	24000824	Chip Jumper, 2125Type (32ZD08G)
GF24	24000824	Chip Jumper, 2125Type (32ZD08G)
GF25	24000824	Chip Jumper, 2125Type (32ZD08G)
GF26	24000824	Chip Jumper, 2125Type (32ZD08G)
GF27	24000824	Chip Jumper, 2125Type (32ZD08G)
GF28	24000824	Chip Jumper, 2125Type (32ZD08G)
GF29	24000824	Chip Jumper, 2125Type (32ZD08G)
GF30	24000824	Chip Jumper, 2125Type (32ZD08G)
GF50	24000824	Chip Jumper, 2125Type (32ZD08G)
GG11	23103859	Coil (Ferrite Bead), TEM2011 (32ZD08G)
GJ02	24000824	Chip Jumper, 2125Type (32ZD08B)
GJ03	24000824	Chip Jumper, 2125Type (32ZD08G)
GJ04	24000824	Chip Jumper, 2125Type (32ZD08G)
GJ07	24000824	Chip Jumper, 2125Type (32ZD08B)
GJ09	24000824	Chip Jumper, 2125Type (32ZD08B)
GJ10	24000824	Chip Jumper, 2125Type (32ZD08B)
GJ14	24000824	Chip Jumper, 2125Type
GJ15	24000824	Chip Jumper, 2125Type
GJ16	24000824	Chip Jumper, 2125Type
GJ17	24000824	Chip Jumper, 2125Type
GJ22	24000824	Chip Jumper, 2125Type
GJ23	24000824	Chip Jumper, 2125Type
GJ30	24000824	Chip Jumper, 2125Type
GS01	24000824	Chip Jumper, 2125Type
GV03	23103832	Chip (Ferrite Bead), TEM2125M

Location No.	Part No.	Description
GV04	23103832	Chip (Ferrite Bead), TEM2125M
GV05	24872101	Chip, 100 ohm, 1/16W
GV06	23103832	Chip (Ferrite Bead), TEM2125M
GV07	24000824	Chip Jumper, 2125Type
GV08	24000824	Chip Jumper, 2125Type
GV11	24000824	Chip Jumper, 2125Type
GV35	24872101	Chip, 100 ohm, 1/16W
GV41	24872102	Chip, 1k ohm, 1/16W
KB01	23904946	Remote Sensor, RPM-676CBR-S
P004	23161702	Terminal, 8P
P402A	23902213	Socket, B-B, 10P
P402B	23368130	Plug, B-B,10P
P403A	23902213	Socket, B-B, 10P
P403B	23368130	Plug, B-B,10P
P501A	23902650	Socket, B-B, 13P
P501B	23367722	Plug, B-B,13P
P502A	23902655	Socket, B-B, 15P
P502B	23367724	Plug, B-B,15P
P512A	23902863	Socket, 20P
P512B	23368520	Plug, B-B, 20P
P513A	23902863	Socket, 20P
P513B	23368520	Plug, B-B, 20P
P661	23363607	Jack, Headphone
△P801	23372052	Power Cord (32ZD08G)
△P801	23372151	Power Cord (32ZD08B)
PD04	23364092	Jack, Pin(Orange)
PD05	A5812240	IC, Optic Receiver, TORX176
PF01	23902655	Socket, B-B, 15P
PF01A	23367724	Plug, B-B,15P
PH01	23902604	Socket, 21P
PH02	23902604	Socket, 21P
PH03	23902604	Socket, 21P
PX01A	23902655	Socket, B-B, 15P
PX01B	23367724	Plug, B-B,15P
PX02A	23902781	Socket, B-B, 12P
PX02B	23368531	Plug, B-B, 12P
S601	23145355	Switch, Slide, 4C-2P
S631	23145412	Switch, Slide, 2C2P
△S801	23344416	Switch, Power
SA01	23145430	Switch, Push, 1C1P
SA02	23145430	Switch, Push, 1C1P
SA03	23145430	Switch, Push, 1C1P
SA04	23145430	Switch, Push, 1C1P
SA05	23145430	Switch, Push, 1C1P
SA06	23145430	Switch, Push, 1C1P
△SR82	23146572	Relay, DC5V, DG5D1-O(M)-2 (32ZD08G)
△SR83	23146570	Relay, DC12V
△V901A	23903027	Socket, CRT, 8P
W661	23351116	Speaker, SPK-1382, 60X120mm, 8 ohm
W662	23351116	Speaker, SPK-1382, 60X120mm, 8 ohm
W663	23351107	Speaker, SPK-1374, 60X120mm, 8 ohm
W664	23351107	Speaker, SPK-1374, 60X120mm, 8 ohm
X4401	23153721	Ceramic Resonator, 503kHz, TCR1023
X501	23153438	Crystal, 16.200MHz
XA01	23153497	Crystal, 16.0 MHz (32ZD08B)



Location No.	Part No.	Description
XA03	23153394	Crystal, 16.000000MHz (32ZD08G)
XF01	23153421	Crystal, 20.48MHz
XF02	23153394	Crystal, 16.000000MHz (32ZD08G)
Z420	23144539	Protector, PRF20005491, 125V, 2A
Z871	23144543	Protector, PRF50005491, 125V, 5A
Z890	23144543	Protector, PRF50005491, 125V, 5A
Z891	23144543	Protector, PRF50005491, 125V, 5A
Z894	23144539	Protector, PRF20005491, 125V, 2A
Z896	23144539	Protector, PRF20005491, 125V, 2A
Z897	23144539	Protector, PRF20005491, 125V, 2A (32ZD08G)
Z897	23144536	Protector, PRF10005491, 125V, 1A (32ZD08B)
Z898	23144539	Protector, PRF20005491, 125V, 2A
ZG01	23144450	Protector, PRF2000F008 (32ZD08G)
ZX101	23103852	Filter, TEM2028AH
ZX201	23103823	Filter, TEM2027D
ZX202	23103823	Filter, TEM2027D
ZX321	23103823	Filter, TEM2027D
ZX341	23103823	Filter, TEM2027D
ZX361	23103823	Filter, TEM2027D
ZX401	23303181	Filter, TEM1012N
ZX402	23303181	Filter, TEM1012N
<b>PC BOARD ASSEMBLIES</b>		
* U102A		BACK-T/AV Board, PB9509A-1
* U102B		DIGITAL-IN Board, PB9509A-2
* U103		D-COMB Borad, PB9510A
* U104		EPG-TEXT Borad, PB9511A (32ZD98G)
* U104		EPG-TEXT Borad, PB9411B (32ZD98B)
* U105		DFS/VER Borad, PB9512A
* U901		CRT DRIVE/DSM Borad, PB9513A
* U902		SIGNAL Borad, PB9514A (32ZD98G)
* U902		SIGNAL Borad, PB9514B (32ZD98B)
* U903		Power Borad, PB9515A (32ZD98G)
* U903		Power Borad, PB9515B (32ZD98B)
* U904		DEF Borad, PB9516A
* U905		EW100Hz Borad, PB9517A
* U906A		CONT-1 Borad, PB9518A-1 (32ZD98G)
* U906A		CONT-1 Borad, PB9518B-1 (32ZD98B)
* U906B		CONT-2 Borad, PB9518A-2 (32ZD98G)
* U906B		CONT-2 Borad, PB9518B-2 (32ZD98B)

Location No.	Part No.	Description
<b>PICTURE TUBE</b>		
△ V901	23312874	Picture Tube, W76ERF031X044
<b>TUNER</b>		
H001	23321344	Tuner, EGA22LWX1 (32ZD08G)
H001	23321345	Tuner, UF822BLW(32ZD08B)
<b>ACCESSORIES</b>		
K902	23306364	Remote Hand Unit, CT-90041 (32ZD08G)
K902	23306365	Remote Hand Unit, CT-90042 (32ZD08B)
AT03	23588265	Battery Cover
Y101	23563926	Owner's Manual, English, 32ZD08G
Y101	23563946	Owner's Manual, English, 32ZD08B
Y102	23563927	Owner's Manual, French, 32ZD08G
Y102	23561801	Warranty (32ZD08B)
Y103	23563928	Owner's Manual, German, 32ZD08G
Y104	23563929	Owner's Manual, Italian, 32ZD08G
Y105	23563930	Owner's Manual, Spanish, 32ZD08G
<b>CABINET PARTS</b>		
A214	23035412	Screw, BTB4X12SZN
A215	23035412	Screw, BTB4X12SZN
A241	70368125	Push Catch for Door
△ A401	23549286	Back Cover
A701	23525882	Case

**THIS PAGE IS  
INTENTIONALLY LEFT  
BLANK.**

# TERMINAL VIEW OF TRANSISTORS

- ① 2SD2253  
(old)  
2SC5243  
2SC5570

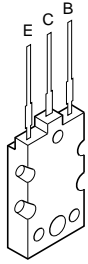

- ② 2SC3852  
2SD1763A  
2SC1569  
2SC4544  
2SA1788  
2SA1306  
2SA1186A

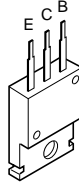

- ③ 2SC752GTM  
2SC2482  
2SC2655  
2SC4721P

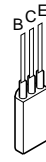

- ④ 2SC752  
2SA562TM  
2SA1015  
2SC1815  
2SC2878  
2SC1740S  
2SC2120  
2SA9335

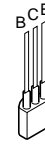

- ⑤ 2SA1788

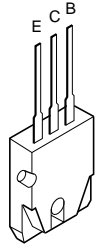

- ⑥ RN2203  
RN2201  
RN2004  
RN1203  
RN1204  
RN2204  
RN1205  
RN1202  
RN1201

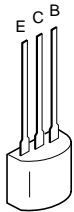

- ⑦ 2SD1554  
2SD2253  
2SD1556  
2SC5143  
2SD2553

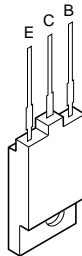

- ⑧ ON4409

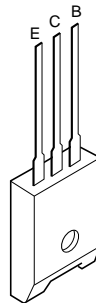

<b>SPECIFICATIONS (Representative: 32ZD08G)</b>																																											
<b>Input Power Rating:</b>	AC 220 ~ 240 Volts, 50 Hz																																										
<b>Aerial Input Impedance:</b>	75 ohm unbalanced type for VHF, UHF and CATV																																										
<b>Receiving Channels:</b>	<table border="0"> <thead> <tr> <th>System</th> <th>Channel</th> <th>VHF</th> <th>UHF</th> <th>CATV</th> <th></th> </tr> </thead> <tbody> <tr> <td>PAL B/G</td> <td>CCIR</td> <td>2 ~ 12</td> <td>21 ~ 69</td> <td>S1 ~ S41</td> <td>X ~ Z + 2,</td> </tr> <tr> <td>SECAM B/G</td> <td>CCIR</td> <td>2 ~ 12</td> <td>21 ~ 69</td> <td>S1 ~ S41</td> <td>X ~ Z + 2,</td> </tr> <tr> <td>PAL D/K</td> <td>CHINA</td> <td>1 ~ 12</td> <td>13 ~ 57</td> <td>Z-1 ~ Z-35</td> <td></td> </tr> <tr> <td>PAL I</td> <td>UK</td> <td></td> <td>21 ~ 69</td> <td></td> <td></td> </tr> <tr> <td>SECAM D/K</td> <td>OIRT</td> <td>1 ~ 12</td> <td>21 ~ 69</td> <td>X-1 ~ X-19</td> <td></td> </tr> <tr> <td>SECAM L FRANCE/CCIR</td> <td>FB ~ F6</td> <td></td> <td>21 ~ 69</td> <td>X ~ Z + 2</td> <td>S1 ~ S41</td> </tr> </tbody> </table>	System	Channel	VHF	UHF	CATV		PAL B/G	CCIR	2 ~ 12	21 ~ 69	S1 ~ S41	X ~ Z + 2,	SECAM B/G	CCIR	2 ~ 12	21 ~ 69	S1 ~ S41	X ~ Z + 2,	PAL D/K	CHINA	1 ~ 12	13 ~ 57	Z-1 ~ Z-35		PAL I	UK		21 ~ 69			SECAM D/K	OIRT	1 ~ 12	21 ~ 69	X-1 ~ X-19		SECAM L FRANCE/CCIR	FB ~ F6		21 ~ 69	X ~ Z + 2	S1 ~ S41
System	Channel	VHF	UHF	CATV																																							
PAL B/G	CCIR	2 ~ 12	21 ~ 69	S1 ~ S41	X ~ Z + 2,																																						
SECAM B/G	CCIR	2 ~ 12	21 ~ 69	S1 ~ S41	X ~ Z + 2,																																						
PAL D/K	CHINA	1 ~ 12	13 ~ 57	Z-1 ~ Z-35																																							
PAL I	UK		21 ~ 69																																								
SECAM D/K	OIRT	1 ~ 12	21 ~ 69	X-1 ~ X-19																																							
SECAM L FRANCE/CCIR	FB ~ F6		21 ~ 69	X ~ Z + 2	S1 ~ S41																																						
<b>Intermediate Frequencies:</b>	PAL, SECAM 50 Hz/60 Hz (For Video Disk play back) 4.43 NTSC (For VCR playback), 3.58 NTSC (For VCR playback) Picture I-F carrier frequency ..... 38.9 MHz (L VL) Sound I-F carrier frequency B/G System ..... 33.4 MHz D/K System ..... 32.4 MHz																																										
<b>Picture Tube:</b>	32 inches, 760 mm (measured on diagonal of viewable picture area) 106° deflection																																										
<b>Sound Output:</b>	10 W + 10 W (at 10% Distortion, Main), 10 W (at 10% Distortion, Center) 10 W + 10 W (at 10% Distortion, Surround)																																										
<b>Speakers:</b>	60 mm x 120 mm oval, 2 pcs (Main), 60 mm x 120 mm oval, 2 pcs (Center)																																										
<b>Aux. Terminals:</b>	21 pin socket (FULL), 21 pin socket (S-VIDEO/AV), MONITOR OUTPUT, STEREO HEADPHONE JACK (3.5mm). DVD Terminal																																										
<b>Cabinet:</b>	Table type																																										
<b>Dimensions:</b>	Height ..... 574 mm Width ..... 918 mm Depth ..... 560 mm																																										
<b>Mass:</b>	60.0 kg																																										

\* Please refer to owner's manual in detail.

**TOSHIBA CORPORATION**  
1-1, SHIBAURA 1-CHOME, MINATO-KU, TOKYO 105-8001, JAPAN



# SCHEMATIC DIAGRAM

MODEL : 32ZD08B / 32ZD08G

**WARNING:** BEFORE SERVICING THIS CHASSIS, READ THE "X-RAY RADIATION PRECAUTION", "SAFETY PRECAUTION" AND "PRODUCT SAFETY NOTICE" ON THE MANUAL FOR THIS MODEL.

**CAUTION:** The international hazard symbols " $\triangle$ " in the schematic diagram and the parts list designate components which have special characteristics important for safety and should be replaced only with types identical to those in the original circuit or specified in the parts list. The mounting position of replacements is to be identical with originals. Before replacing any of these components, read carefully the PRODUCT SAFETY NOTICE on the MANUAL for this model. Do not degrade the safety of the receiver through improper servicing.

## NOTE:

- RESISTOR** Resistance is shown in ohm [K = 1.000, M = 1.000.000]. All resistors are 1/6W and 5% tolerance carbon resistor, unless otherwise noted as the following marks.  
1/2R = Metal or Metal oxide of 1/2 watt                      1/2S = Carbon composition of 1/2 watt  
1RF = Fuse resistor of 1 watt                                      10W = Cement of 10 watt  
K =  $\pm 10\%$     G =  $\pm 2\%$     F =  $\pm 1\%$
- CAPACITOR** Unless otherwise noted in schematic, all capacitor values less than 1 are expressed in  $\mu\text{F}$ , and the values more than 1 in pF.  
All capacitors are ceramic 50V, unless otherwise noted as the following marks.  
 Electrolytic capacitor                       Mylar capacitor
- The parts indicated with " $\triangle$ " have special characteristics, and should be replaced with identical parts only.
- Voltages read with DIGITAL MULTI-METER from point indicated to chassing ground, using a color bar signal with all controls at normal, line voltage 220 volts.
- Waveforms are taken receiving color bar signal with enough sensitivity.
- Voltage reading shown are nominal values and may vary  $\pm 20\%$  except H.V.

**SCHEMATIC DIAGRAM MODEL : 32ZD08B/32ZD08G**

**WARNING:** BEFORE SERVICING THIS CHASSIS, READ THE "X-RAY RADIATION PRECAUTION", "SAFETY PRECAUTION" AND "PRODUCT SAFETY NOTICE" ON THE MANUAL FOR THIS MODEL.

**CAUTION:** The international hazard symbols "△" in the schematic diagram and the parts list designate components which have special characteristics important for safety and should be replaced only with types identical to those in the original circuit or specified in the parts list. The mounting position of replacements to be identical with originals. Before replacing any of these components, read carefully the PRODUCT SAFETY NOTICE on the MANUAL for this model. Do not degrade the safety of the receiver through improper servicing.

- NOTE:**
- RESISTOR** Resistance is shown in ohm [K = 1,000, M = 1,000,000]. All resistors are 1/6W and 5% tolerance carbon resistor, unless otherwise noted as the following marks.  
 1/2R = Metal or Metal oxide of 1/2 watt      1/2S = Carbon composition of 1/2 watt  
 1RF = Fuse resistor of 1 watt      10W = Cement of 10 watt  
 K = ±10%      G = ±2%      F = ±1%
  - CAPACITOR** Unless otherwise noted in schematic, all capacitor values less than 1 are expressed in µF, and the values more than 1 in pF.  
 All capacitors are ceramic 50V, unless otherwise noted as the following marks.  
 —|— Electrolytic capacitor      —|— Mylar capacitor
  - The parts indicated with "△" have special characteristics, and should be replaced with identical parts only.

4. Voltages read with DIGITAL MULTI-METER from point indicated to chassis ground, using a color bar signal with all controls at normal, line voltage 220 volts.
5. Waveforms are taken receiving color bar signal with enough sensitivity.
6. Voltage reading shown are nominal values and may vary ±20% except H.V.

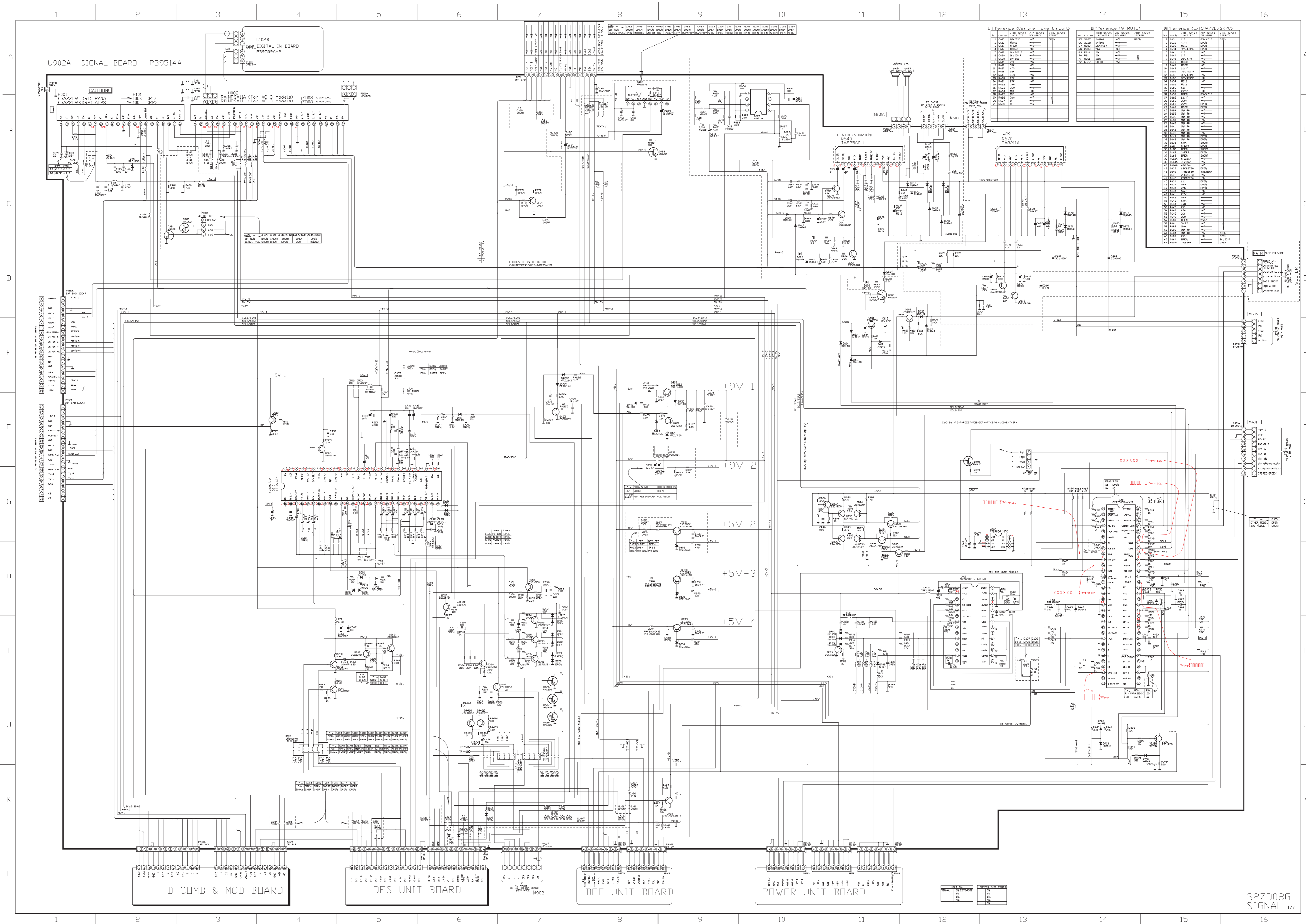

1

2

3

4

A

B

C

D

E

F

# U902A SIGNAL BOARD PB9514A

U102B  
DIGITAL-IN BOARD  
PB9509A-2

CAUTION!

TO PWR5/DEF  
GND

H001  
EGA22LW (R1) PANA  
EGA22LWXIKR2) ALPS

R101  
100K (R1)  
100 (R2)

H002  
RA MPSA11A (for AC-3 models) ;Z  
RB MPSA11 (for AC-3 models) ;Z

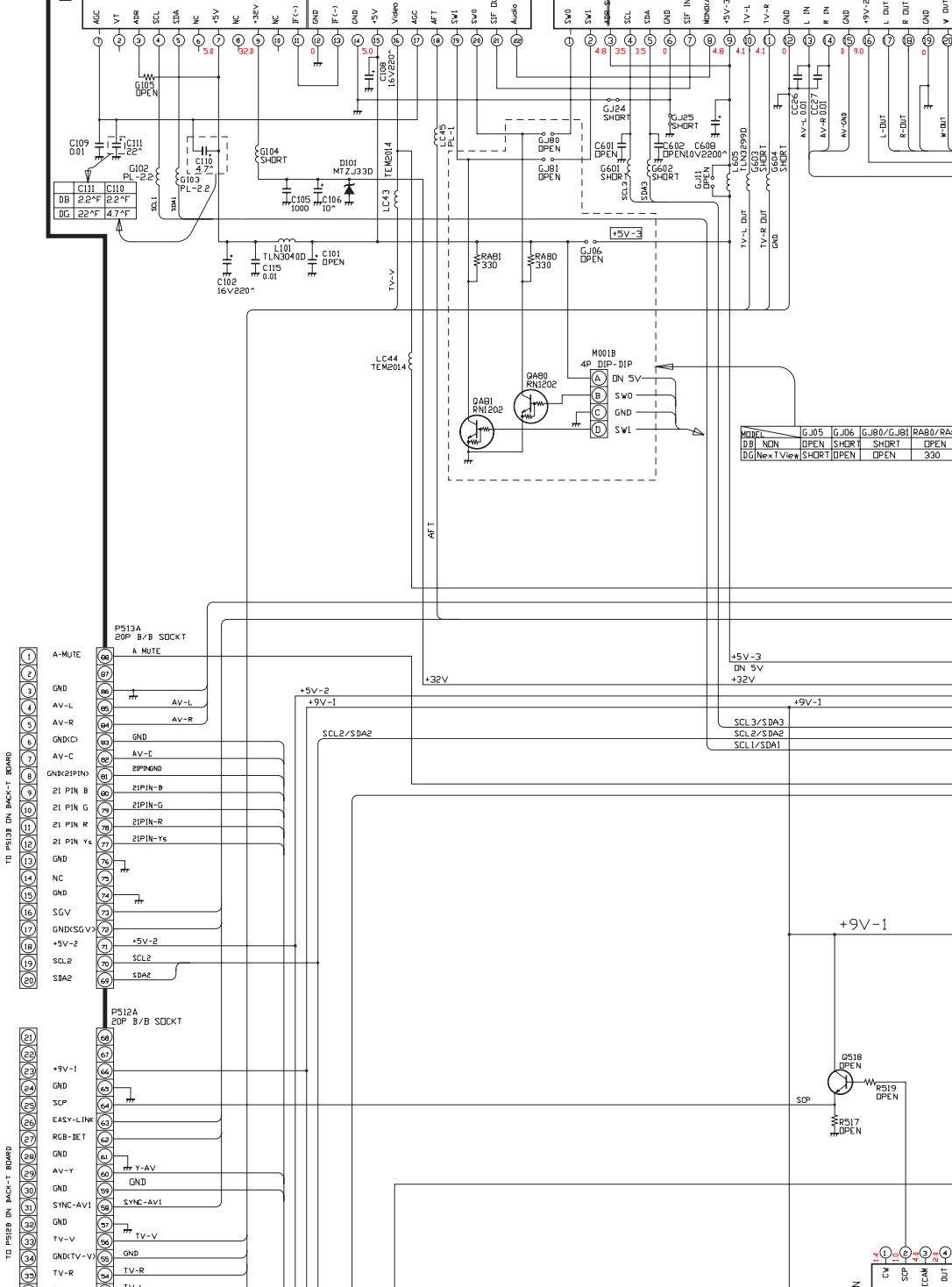



AL-IN BOARD  
99A-2

AV-D00	AV-D01	AV-D02	AV-D03	AV-D04	AV-D05	AV-D06	AV-D07	AV-D08	AV-D09	AV-D10	AV-D11	AV-D12	AV-D13	AV-D14	AV-D15	AV-D16	AV-D17	AV-D18	AV-D19	AV-D20	
AV-D00	L-DUT	R-DUT	W-DUT	C-DUT	SC-DUT	SP-DUT	FP1	DPS	DPA												

PD01A  
3P2.5mm

G_J06	G_J07	G_J08	G_J09	G_J10	G_J11	RAB0	RAB1	QAB0	QAB1
SHORT	SHORT	SHORT	SHORT	SHORT	SHORT	OPEN	OPEN	OPEN	OPEN
OPEN	OPEN	OPEN	OPEN	OPEN	OPEN	330	330	RN1204	RN1202

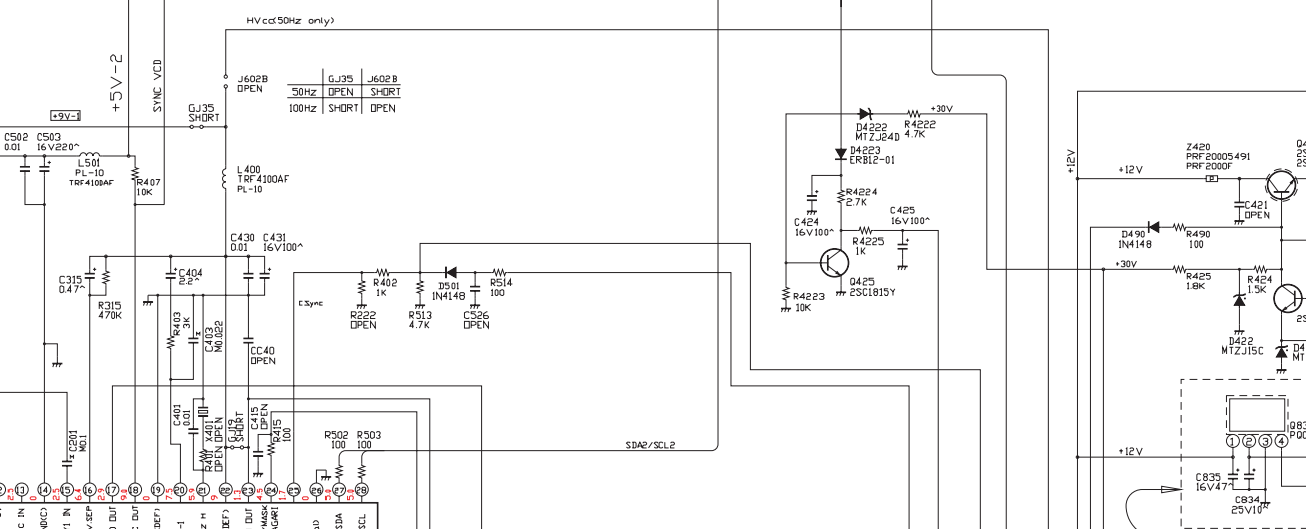
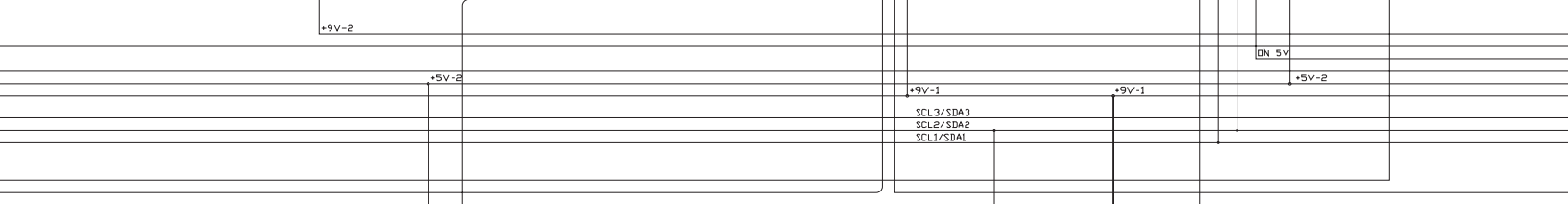

1	2	3	4	5	6	7	8	9	10	11	12	13	14	15
TEXT R	TEXT B	TEXT-MUTE	TEXT RESET	NC	GND	TEXT G	YS DUT	NC	TV/TEXT-SW	V-AV	GND	V-DUT	SCL1	SCL2

G_J82	QAB2	QAB3	RAB2	CA80	C
NC	SHORT	OPEN	OPEN	OPEN	OPEN
DGNextView	MM1111X	RN1204	10k	16V47	0

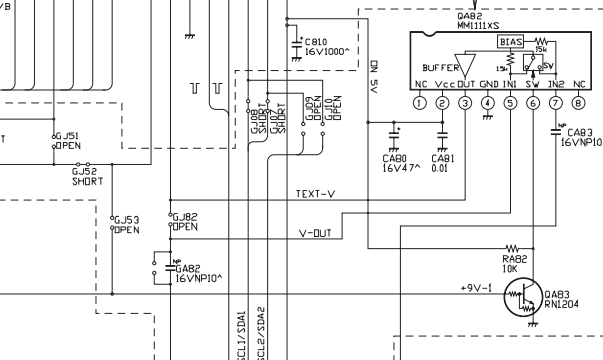

B TEXT RESET  
C TV/TEXT SW

L-DUT/R-DUT/W-DUT/C-DUT  
C-MUTE(OPT4)/MUTE-SCRIPTS(IP1)

GAB2	GAB3	GAB2	CAB0	CAB1	GAB2	CAB3	GJ04	GJ04	GJ07	GJ08	GJ09	GJ10	GJ51	GJ52	GJ53	GJ60
OPEN	OPEN	OPEN	OPEN	OPEN	SHORT	OPEN	OPEN	SHORT	OPEN	OPEN	SHORT	SHORT	SHORT	OPEN	SHORT	OPEN
11X3	RN1204	10k	16V47*100	16VN10*	16VN10*	SHORT	OPEN	SHORT	SHORT	OPEN	OPEN	OPEN	SHORT	OPEN	SHORT	OPEN

Difference (Centre Ton

No.	LocNo.	Z008 series AC3/DTS	Z07 series DDL-PRD
1	C615	NP4.7*	
2	C616	M0018	
3	C617	M1000	
4	C618	M0082	
5	C619	16V220*F	
6	C620	16V100*F	
7	D620	8A4558	
8	R615	27K	
9	R616	33K	
10	R617	4.7K	
11	R618	22K	
12	R619	4.7K	
13	R620	27K	
14	R621	27K	
15	R622	3.3K	
16	R623	3.3K	
17	R624	10K	
18	R625	10K	
19	R626	5.6K	
20	R627	1K	
21	R628	1K	

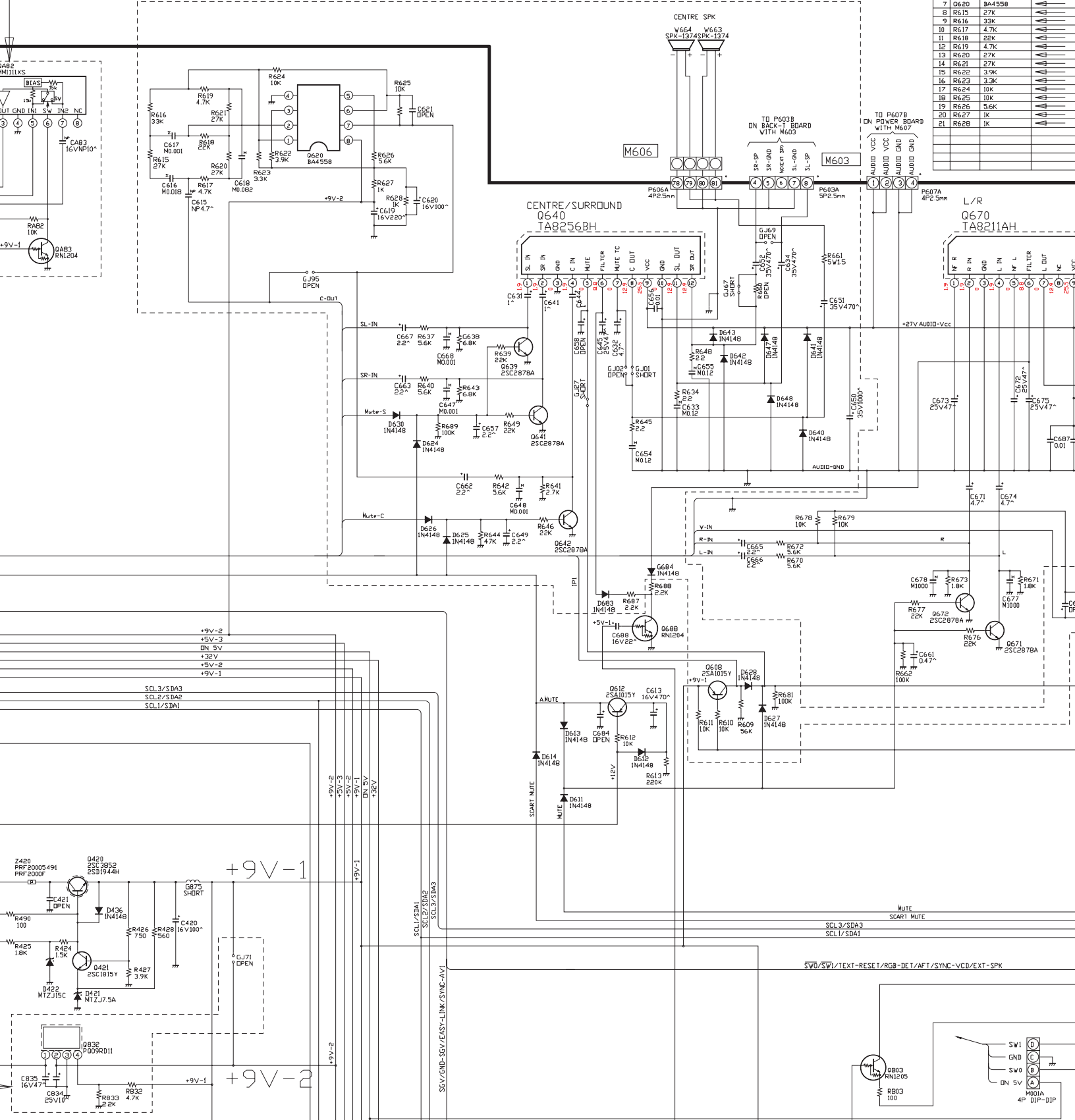

Centre Tone Circuit

Z08 series AC3/DTS	Z07 series DDL-PRD	Z06 series STEREO
NP47-F		OPEN
M018		
M1000		
M0082		
16V220*F		
16V100*F		
1M4958		
27K		
33K		
4.7K		
22K		
4.7K		
27K		
27K		
3.9K		
3.3K		
10K		
10K		
5.6K		
1K		
1K		

Difference (W-MUTE)

No.	Loc.No.	Z08 series AC3/DTS	Z07 series DDL-PRD	Z06 series STEREO
65	D627	1N4148		
66	D628	1N4148		
67	D608	2SA1015Y		
68	R609	56K		
69	R610	10K		
70	R611	10K		
71	R681	100K		
72	G127	SHORT		

Difference (L/R/W/SL/SR/C)

No.	Loc.No.	Z08 series AC3/DTS	Z07 series DDL-PRD	Z06 series STEREO
1	C631	1*F		25V47*F
2	C632	4.7*F		OPEN
3	C633	M012		OPEN
4	C634	35V470*F		OPEN
5	C641	1*F		
6	C644	1*F		
7	C645	25V47*F		
8	C647	M0001		
9	C648	M0001		
10	C649	2.2*F		
11	C650	35V1000*F		
12	C651	35V470*F		
13	C652	35V470*F		
14	C654	M012		
15	C655	M012		
16	C656	0.01		
17	C657	2.2*F		
18	C658	OPEN	25V47*F	
19	C662	2.2*F		
20	C663	2.2*F		
21	C667	2.2*F		OPEN
22	C668	M0001		OPEN
23	D624	1N4148		
24	D625	1N4148		
25	D626	1N4148		
26	D630	1N4148		
27	D640	1N4148		
28	D641	1N4148		
29	D642	1N4148		
30	D643	1N4148		
31	D647	1N4148		OPEN
32	D648	1N4148		OPEN
33	G538	6.8K		SHORT
34	G101	SHORT		OPEN
35	G102	OPEN		SHORT
36	G167	SHORT		OPEN
37	G169	OPEN		SHORT
38	P603A	5P2.5mm		
39	P604A	7P2.5mm		
40	P606A	4P2.5mm		
41	D639	2SC2878A		OPEN
42	D640	TAB256BH	TAB211AH	
43	D641	2SC2878A		
44	D642	2SC2878A		
45	R634	2.2		OPEN
46	R637	5.6K		OPEN
47	R639	22K		OPEN
48	R640	5.6K		
49	R641	2.7K		
50	R642	5.6K		
51	R643	6.8K		
52	R644	4.7K		
53	R645	2.2		
54	R646	22K		
55	R649	2.2		
56	R649	22K		
57	R660	OPEN	5V1.5	
58	R661	5V1.5		
59	R689	100K		
60	D683	1N4148		
61	G684	1N4148		SHORT
62	R687	2.2K		OPEN
63	C664	OPEN		16V10*F
64	P604A	7P2.5mm		OPEN

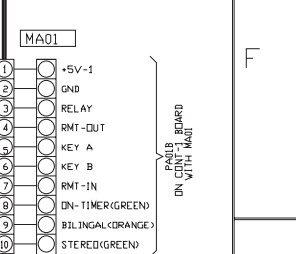
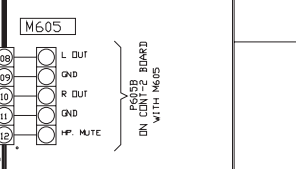
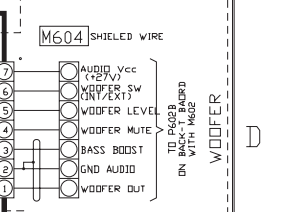
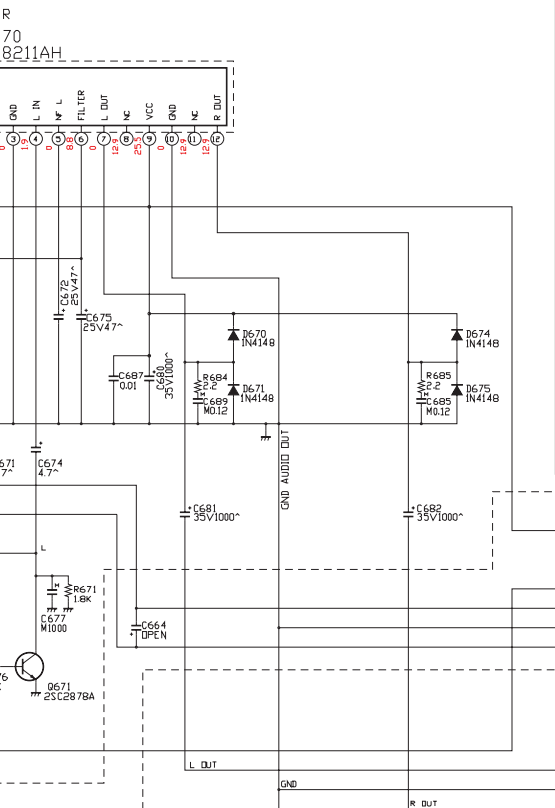

XXXXXXXX I 5Vp-p SDA

A

B

C

D

E

F

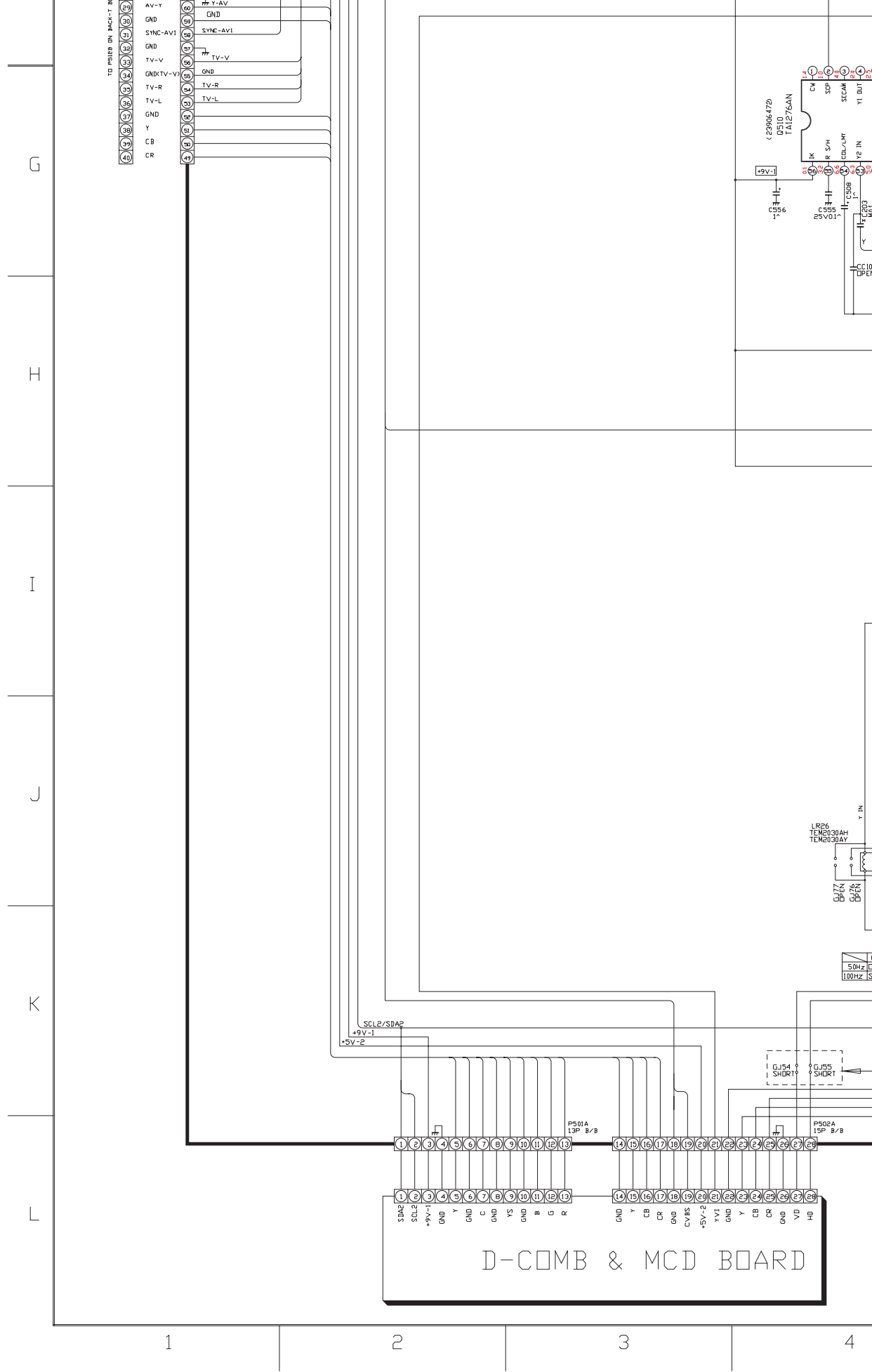

TO PAPER ON 340C-1 IN

- AV-Y
- GND
- SYNC-AV1
- GND
- TV-V
- GND
- TV-R
- TV-L
- GND
- Y
- CB
- CR

G

H

I

J

K

L

1

2

3

4

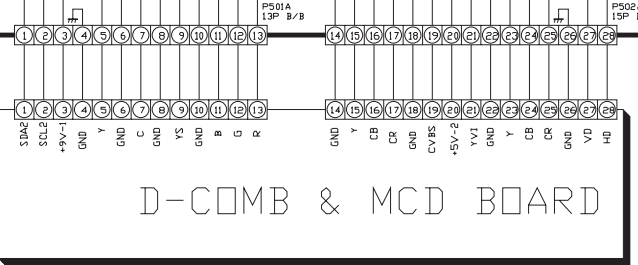

SCL2/SBAP  
+9V-1  
+5V-2

P501A  
13P B/B

GJ54  
SHORT

GJ55  
SHORT

P502A  
13P B/B

LRP6  
TEMP30AH  
TEMP30AY

50Hz  
100Hz

(2390647D)  
0510  
TAI276AN

+9V-1

C556

C555

C558

C559

C560

C561

C562

C563

C564

C565

C566

C567

C568

C569

C570

C571

C572

C573

C574

C575

C576

C577

C578

C579

C580

C581

C582

C583

C584

C585

C586

C587

C588

C589

C590

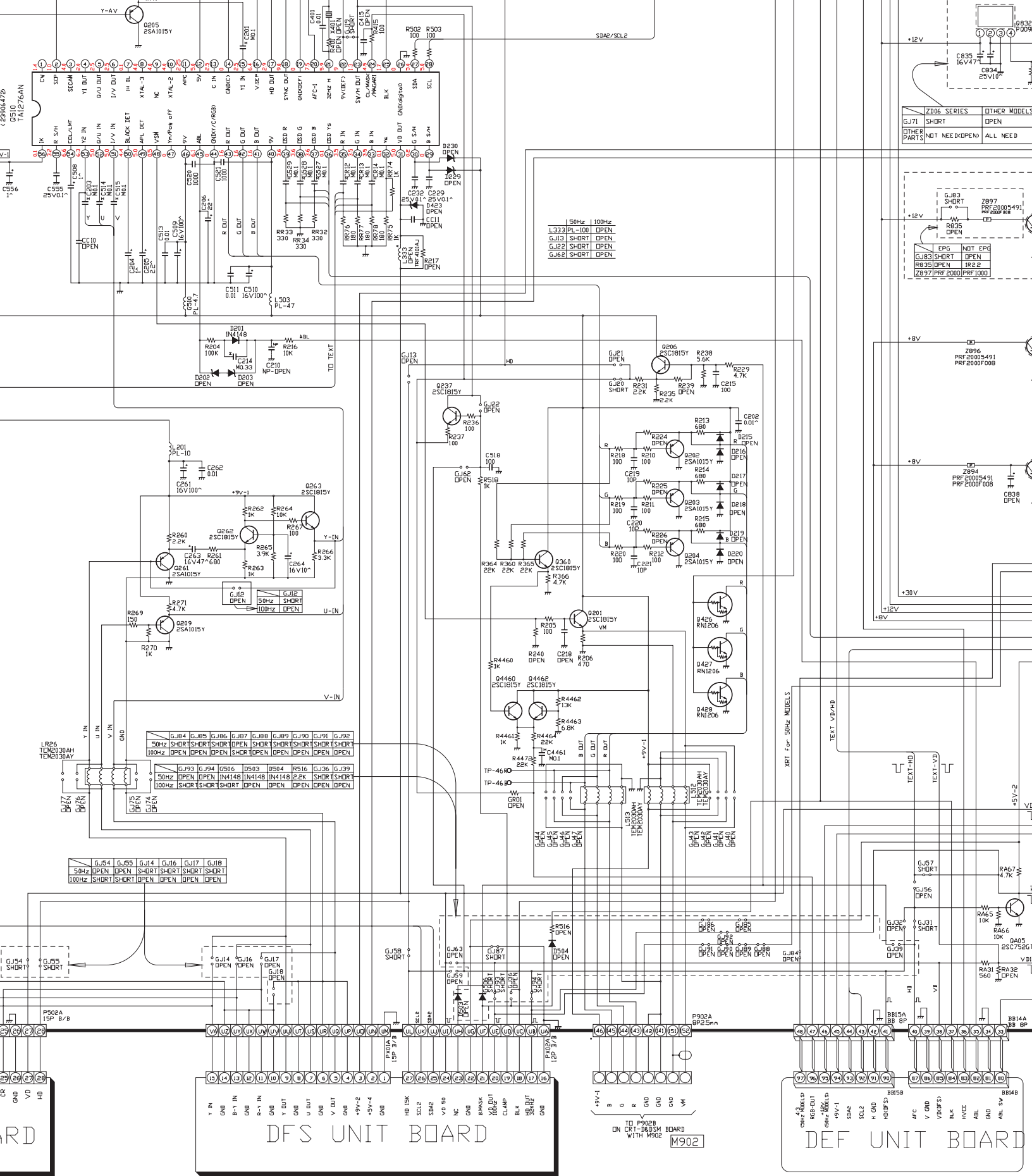

50Hz	100Hz
L333 PL-100	OPEN
GJ13	SHORT
GJ22	SHORT
GJ21	SHORT

Z006 SERIES	OTHER MODELS
GJ71	SHORT
OTHER PARTS	NOT NEEDED
	OPEN
	ALL NEED

EPG	NOT EPG
GJ83	SHORT
R835	OPEN
Z897	PRF 20005491
	PRF 20007008

GJ84	GJ85	GJ86	GJ87	GJ88	GJ89	GJ90	GJ91	GJ92
50Hz	SHORT	SHORT	SHORT	OPEN	SHORT	SHORT	SHORT	SHORT
100Hz	OPEN	OPEN	OPEN	SHORT	OPEN	OPEN	OPEN	OPEN

GJ93	GJ94	GJ96	D503	D504	R516	GJ36	GJ39
50Hz	OPEN	OPEN	IN4148	IN4148	IN4148	22K	SHORT
100Hz	SHORT	SHORT	SHORT	OPEN	OPEN	OPEN	OPEN

GJ54	GJ55	GJ4	GJ6	GJ7	GJ8
50Hz	OPEN	OPEN	SHORT	SHORT	SHORT
100Hz	SHORT	SHORT	OPEN	OPEN	OPEN

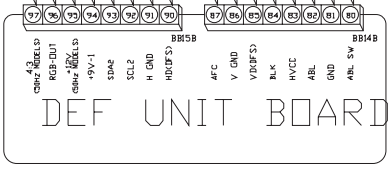
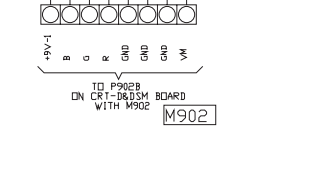
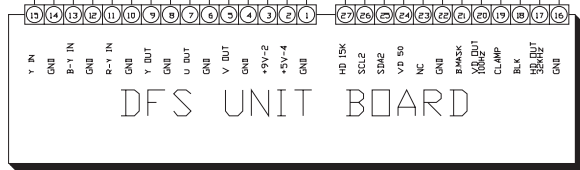

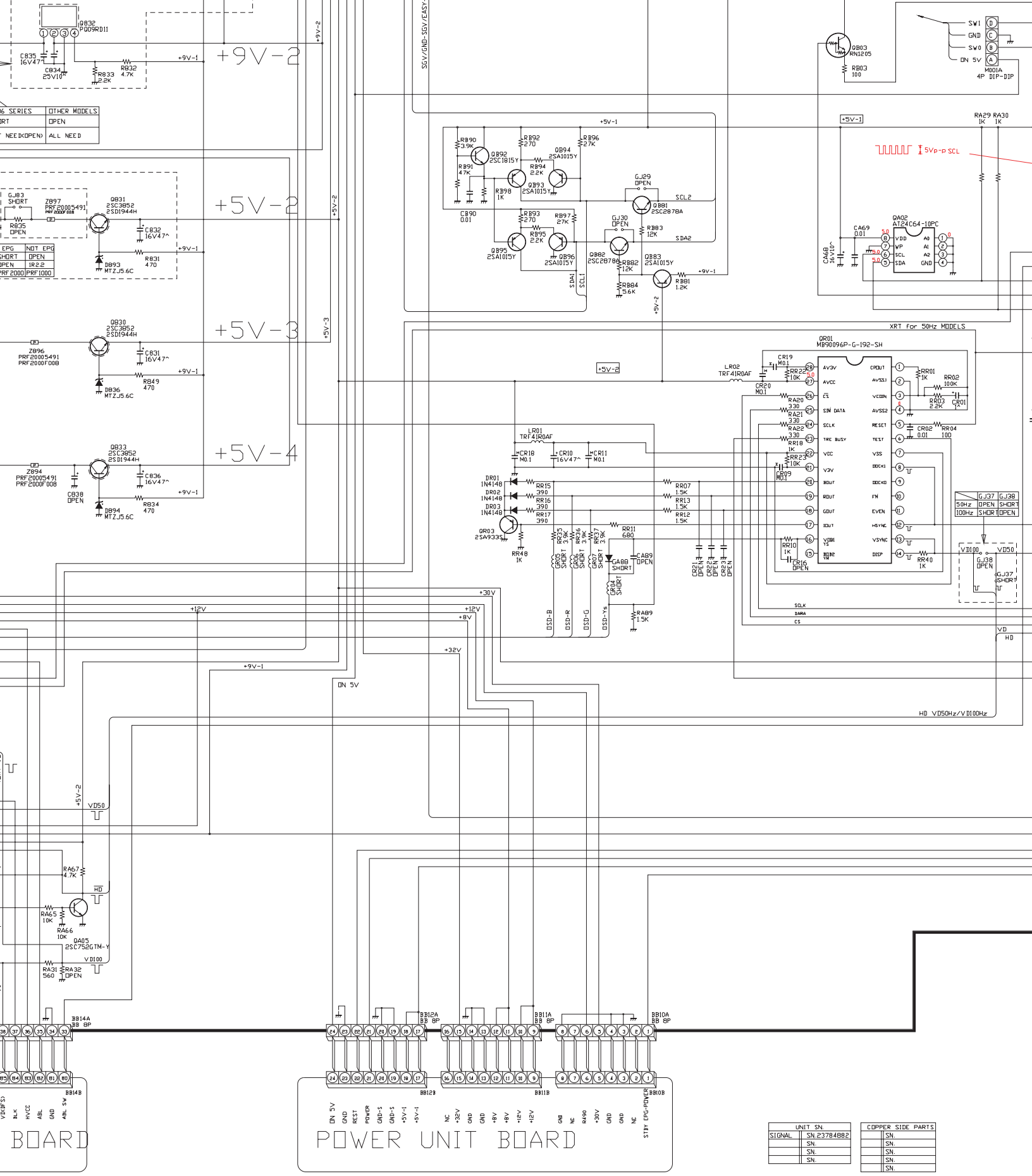

BOARD

POWER UNIT BOARD

UNIT SN.		COPPER SIDE PARTS	
SIGNAL	SN 23784882	SN.	
		SN.	
		SN.	
		SN.	

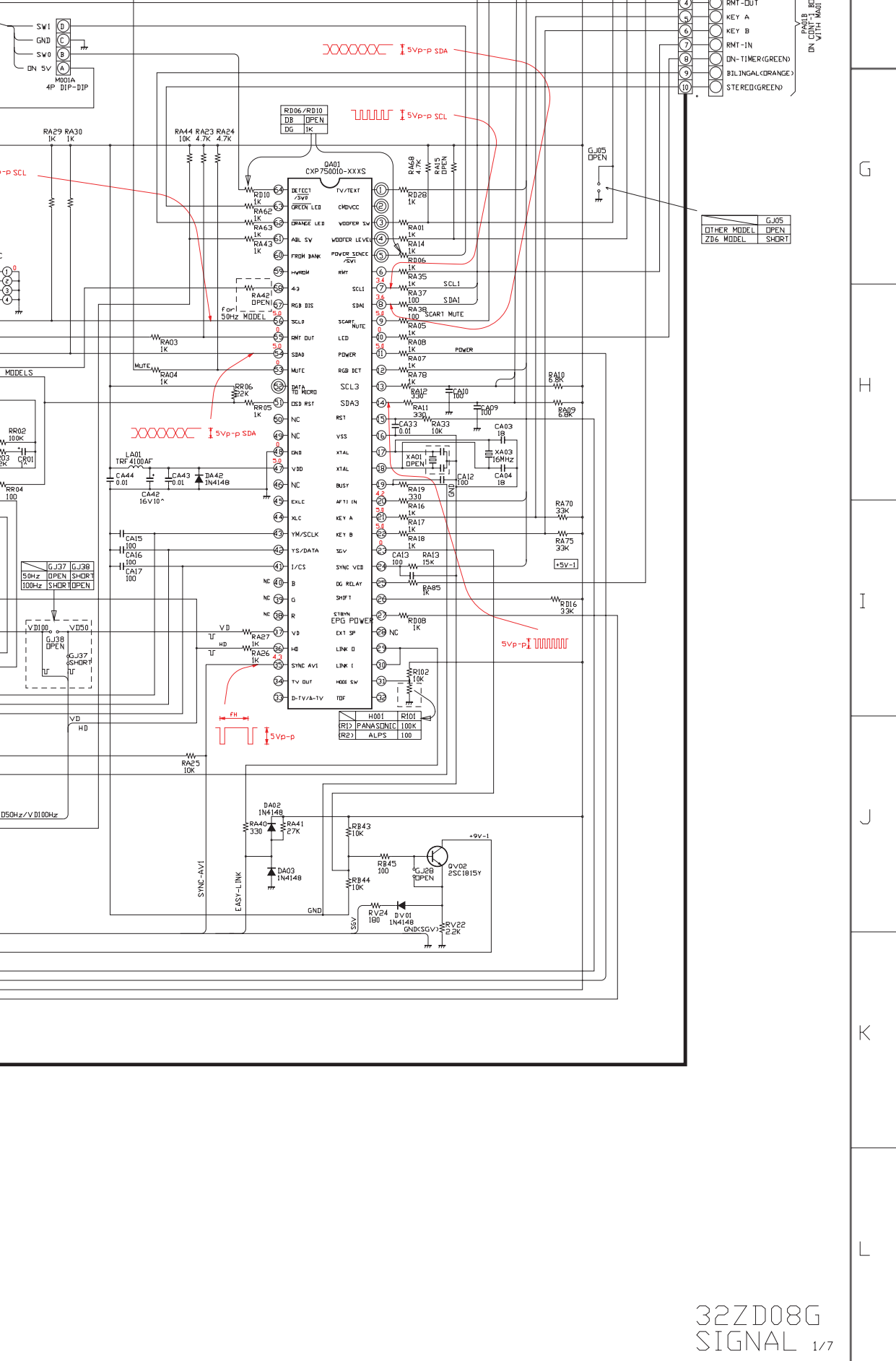

U903 POWER BOARD PB9515A

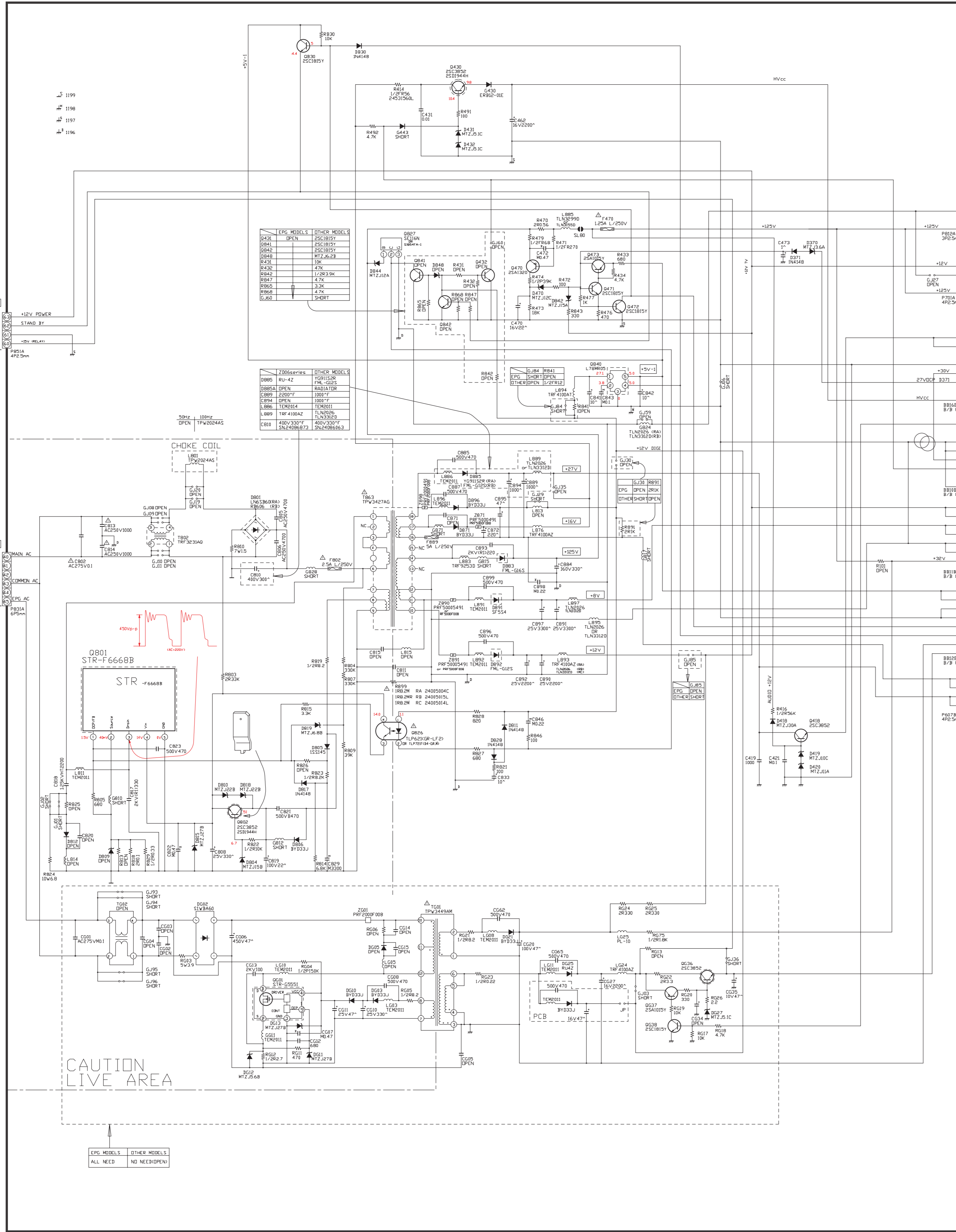

U904 DEF BOARD PB9516A  
100Hz MODEL ONLY

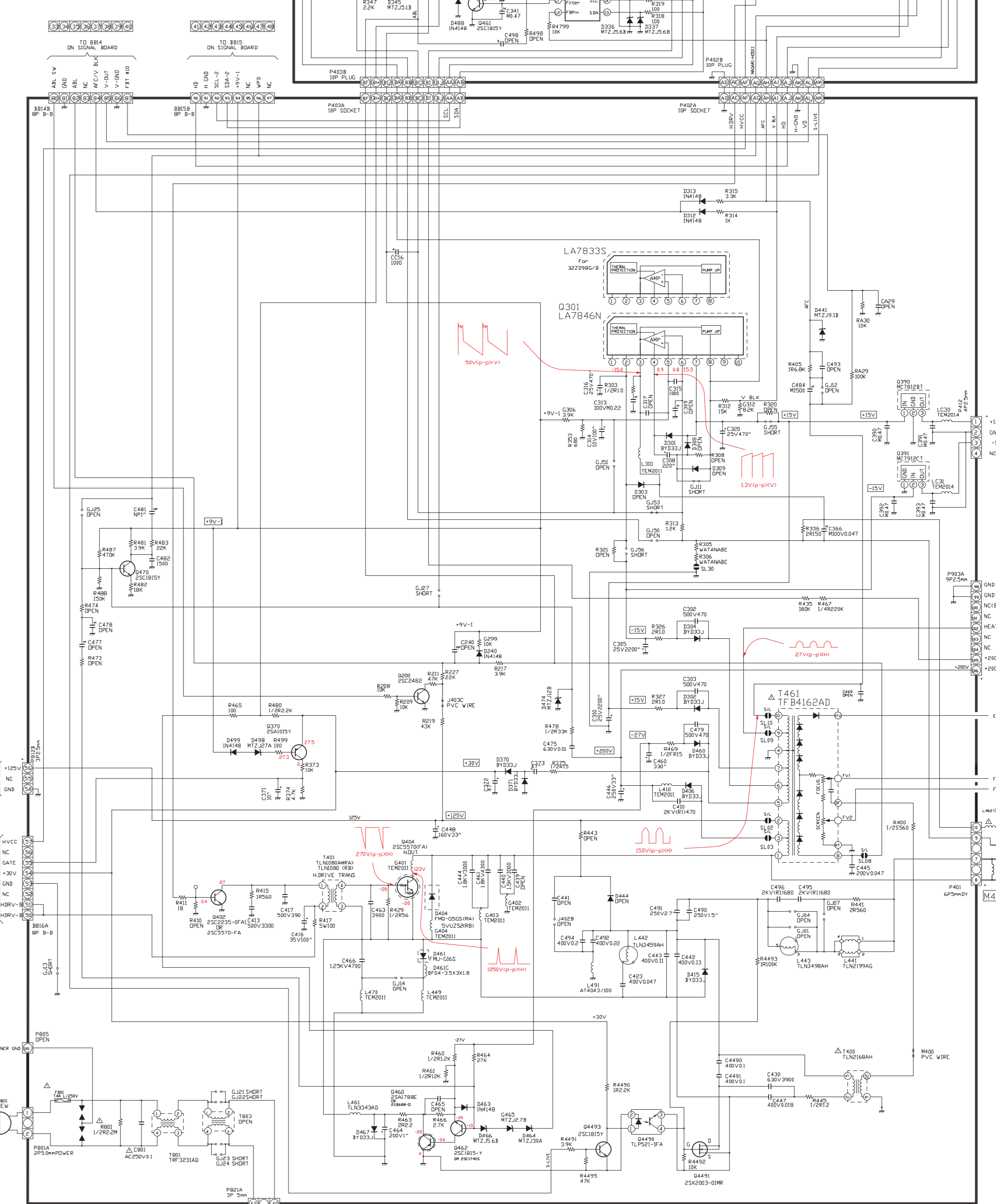

U905 EW100Hz BOARD PB9517A

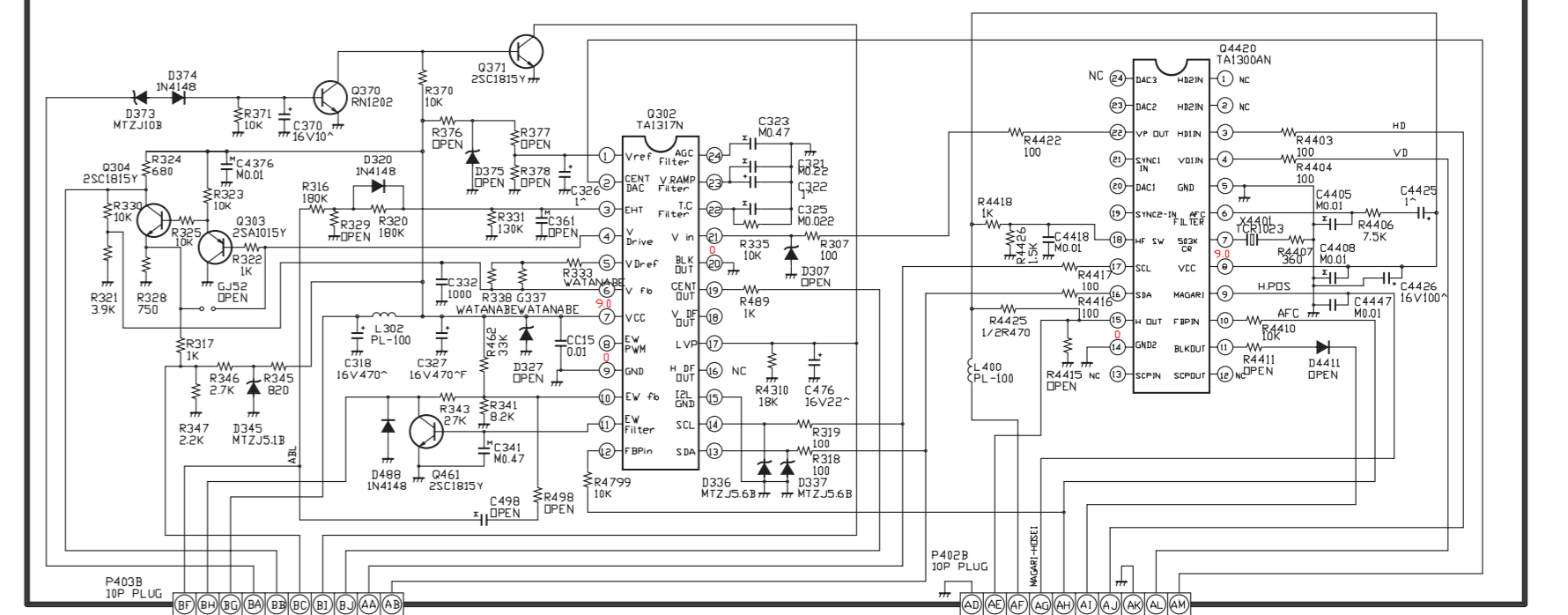

1199  
1198  
1197  
1196

U903 MODEL	OTHER MODEL
D438	OPEN
D439	OPEN
D440	OPEN
D441	OPEN
D442	OPEN
D443	OPEN
D444	OPEN
D445	OPEN
D446	OPEN
D447	OPEN
D448	OPEN
D449	OPEN
D450	OPEN
D451	OPEN
D452	OPEN
D453	OPEN
D454	OPEN
D455	OPEN
D456	OPEN
D457	OPEN
D458	OPEN
D459	OPEN
D460	OPEN

U904 MODEL	OTHER MODEL
D895	OPEN
D896	OPEN
D897	OPEN
D898	OPEN
D899	OPEN
D900	OPEN
D901	OPEN
D902	OPEN
D903	OPEN
D904	OPEN
D905	OPEN
D906	OPEN
D907	OPEN
D908	OPEN
D909	OPEN
D910	OPEN
D911	OPEN
D912	OPEN
D913	OPEN
D914	OPEN
D915	OPEN
D916	OPEN
D917	OPEN
D918	OPEN
D919	OPEN
D920	OPEN

U905 MODEL	OTHER MODEL
C204	OPEN
C205	OPEN
C206	OPEN
C207	OPEN
C208	OPEN
C209	OPEN
C210	OPEN
C211	OPEN
C212	OPEN
C213	OPEN
C214	OPEN
C215	OPEN
C216	OPEN
C217	OPEN
C218	OPEN
C219	OPEN
C220	OPEN
C221	OPEN
C222	OPEN
C223	OPEN
C224	OPEN
C225	OPEN
C226	OPEN
C227	OPEN
C228	OPEN
C229	OPEN
C230	OPEN

U903 MODEL	OTHER MODEL
D438	OPEN
D439	OPEN
D440	OPEN
D441	OPEN
D442	OPEN
D443	OPEN
D444	OPEN
D445	OPEN
D446	OPEN
D447	OPEN
D448	OPEN
D449	OPEN
D450	OPEN
D451	OPEN
D452	OPEN
D453	OPEN
D454	OPEN
D455	OPEN
D456	OPEN
D457	OPEN
D458	OPEN
D459	OPEN
D460	OPEN

NOTE  
The marking (OPEN) means that there are no components on the PCB though there are the markings of parts No. on the PCB. It is noted open circuit.

UNIT SN	EXPRES. SIDE PARTS
U903	OPEN
U904	OPEN
U905	OPEN
U906	OPEN
U907	OPEN
U908	OPEN
U909	OPEN
U910	OPEN
U911	OPEN
U912	OPEN
U913	OPEN
U914	OPEN
U915	OPEN
U916	OPEN
U917	OPEN
U918	OPEN
U919	OPEN
U920	OPEN



1

2

3

4

A

B

C

D

E

F

# U903 POWER BOARD PB9515A

- LS 1199
- HS 1198
- HS 1197
- HS 1196

EPG MODELS	OTHER MODELS
Q431	OPEN
Q841	2SC1815Y
Q842	2SC1815Y
D848	MTZJ6.2B
R431	10K
R432	47K
R842	1/2R3.9K
R847	4.7K
R865	3.3K
R868	4.7K
GJ60	SHORT

ZD06series	OTHER MODELS
D885	RU-4Z
D885A	OPEN
G889	2200*F
C894	OPEN
L889	TRF 4100AZ
C810	400V 330*F

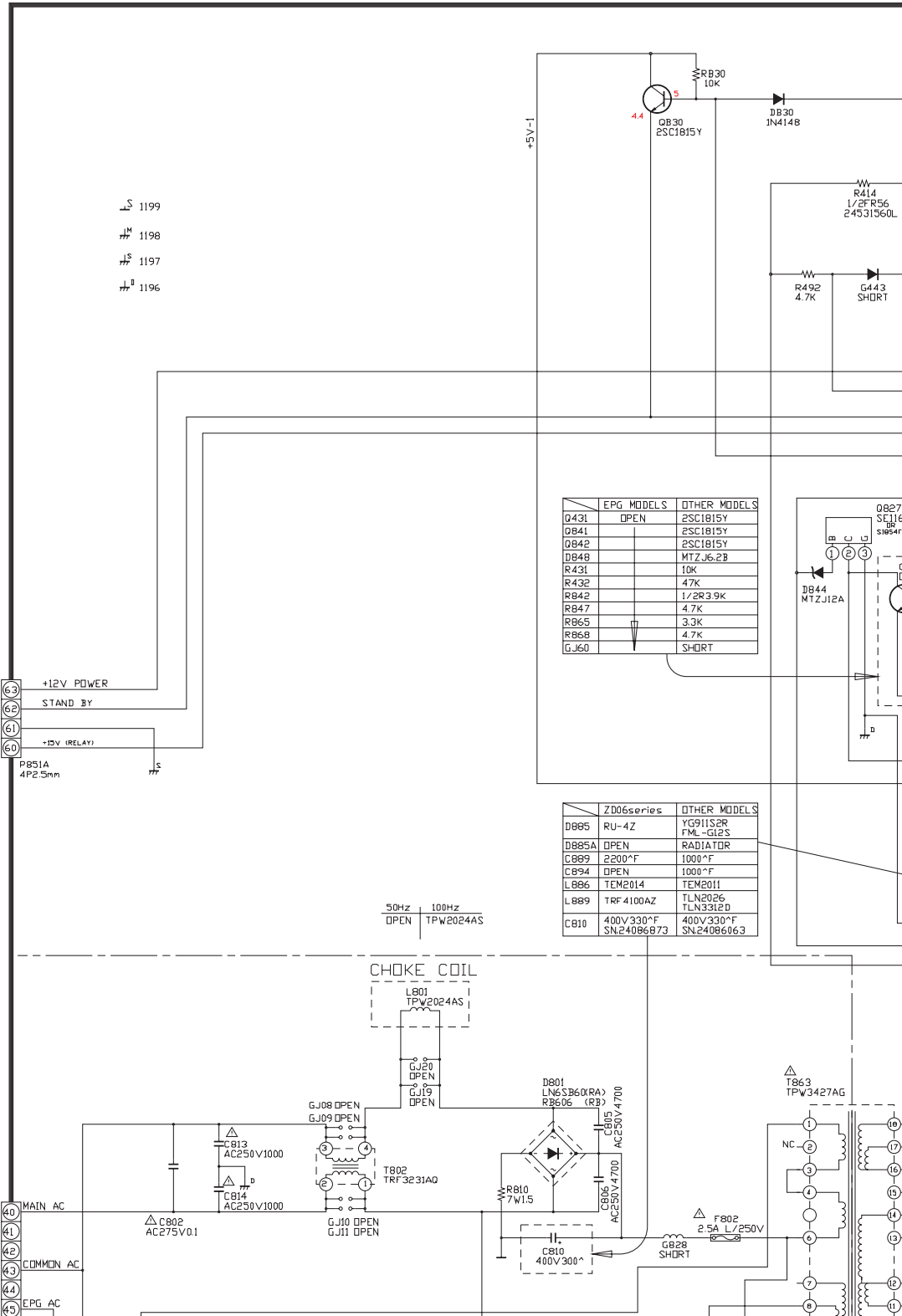
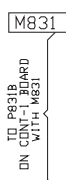
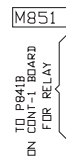

50Hz 100Hz  
OPEN TPW2024AS

### CHOKE COIL

W R414  
1/2R R56  
24531560L

W R492  
4.7K

Q827  
SEJ16  
S1854

D844  
MTZJ12A

T863  
TPW3427AG

F802  
2.5A L/250V

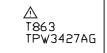
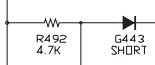
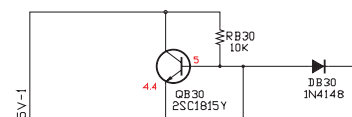

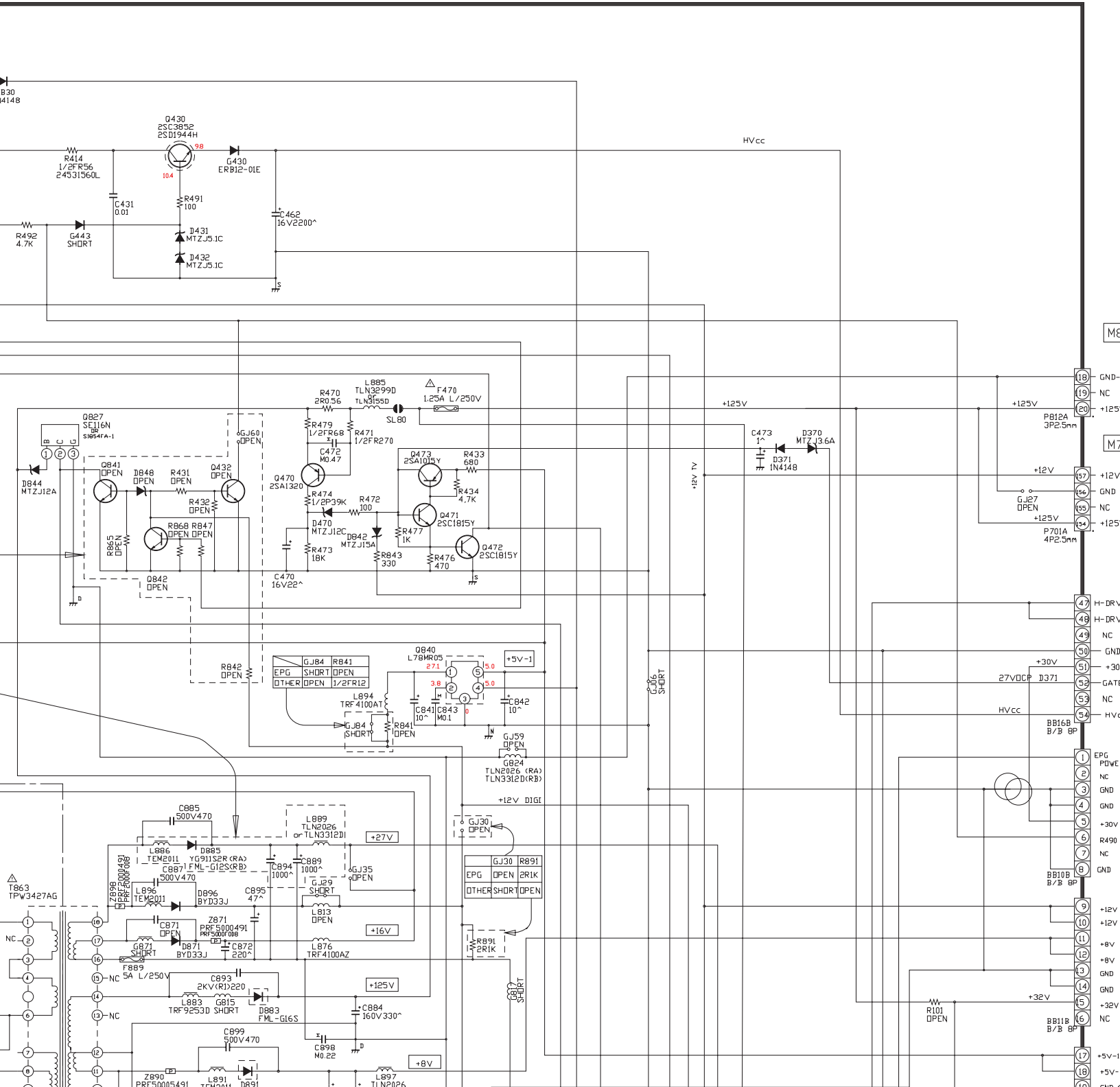

U905 EW100Hz BOARD PB9517A

U904 DEF BOARD PB9516A  
100Hz MODEL ONLY

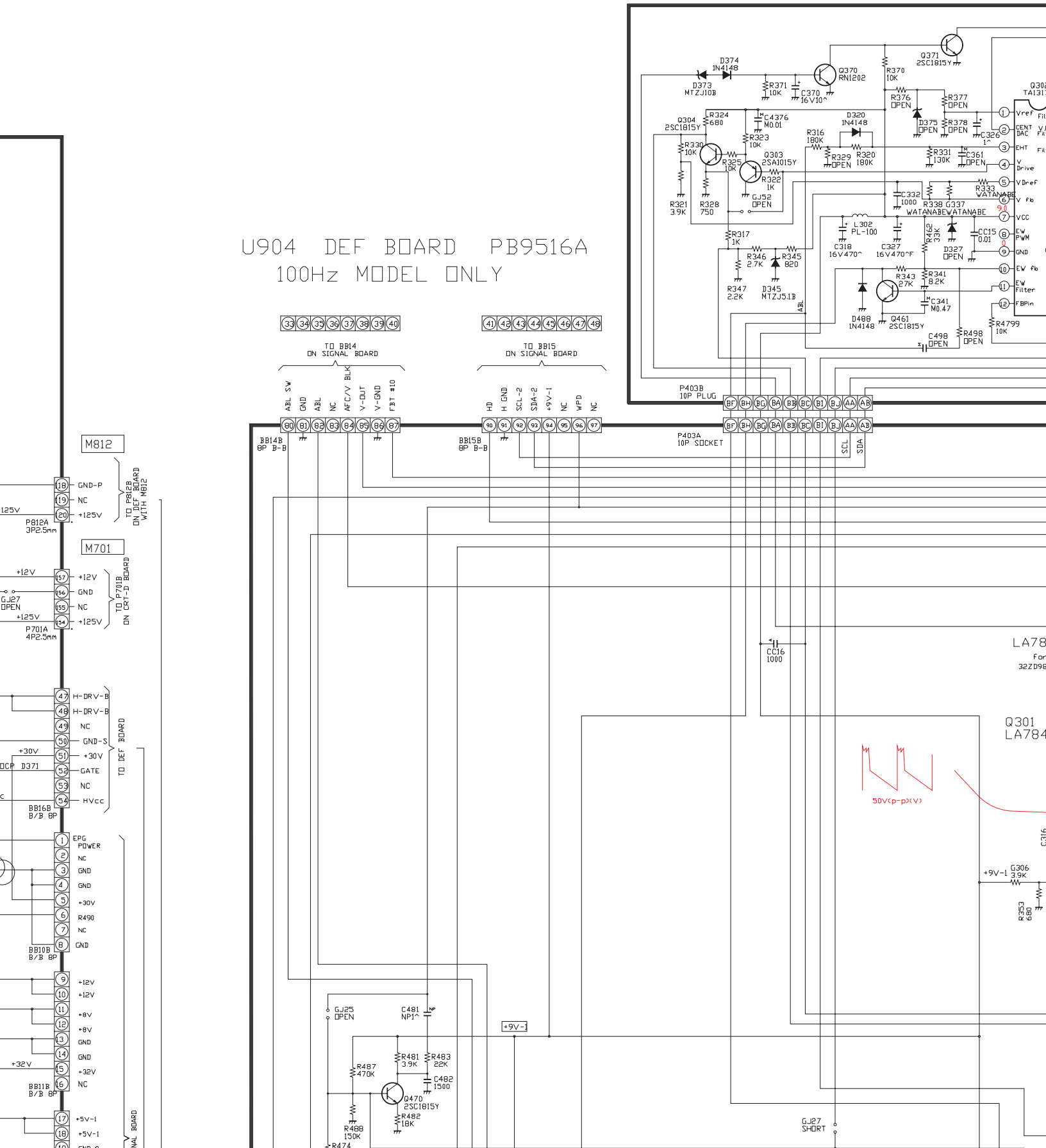

PB9517A

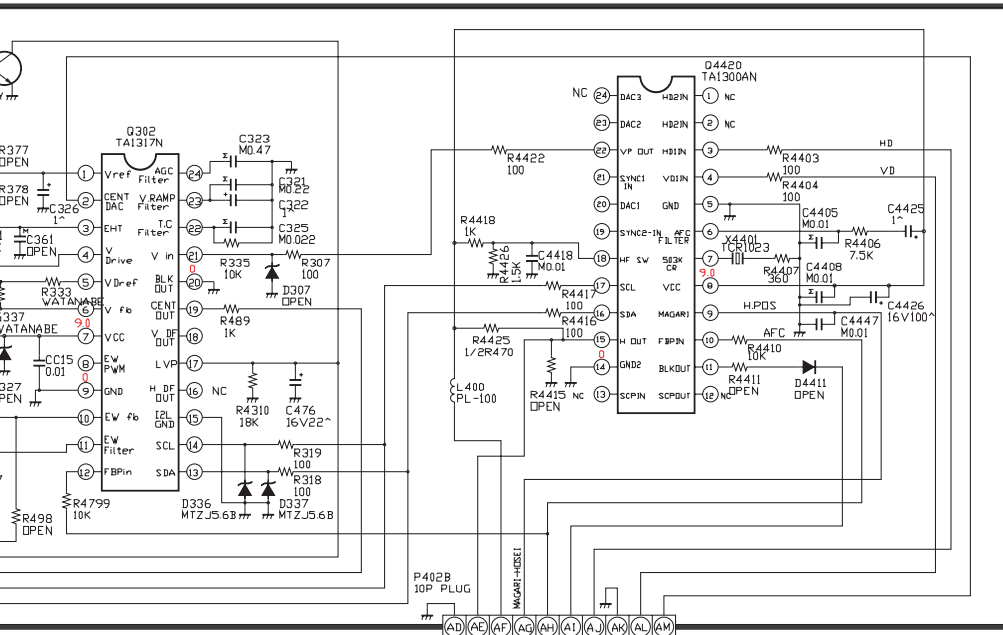

A

B

C

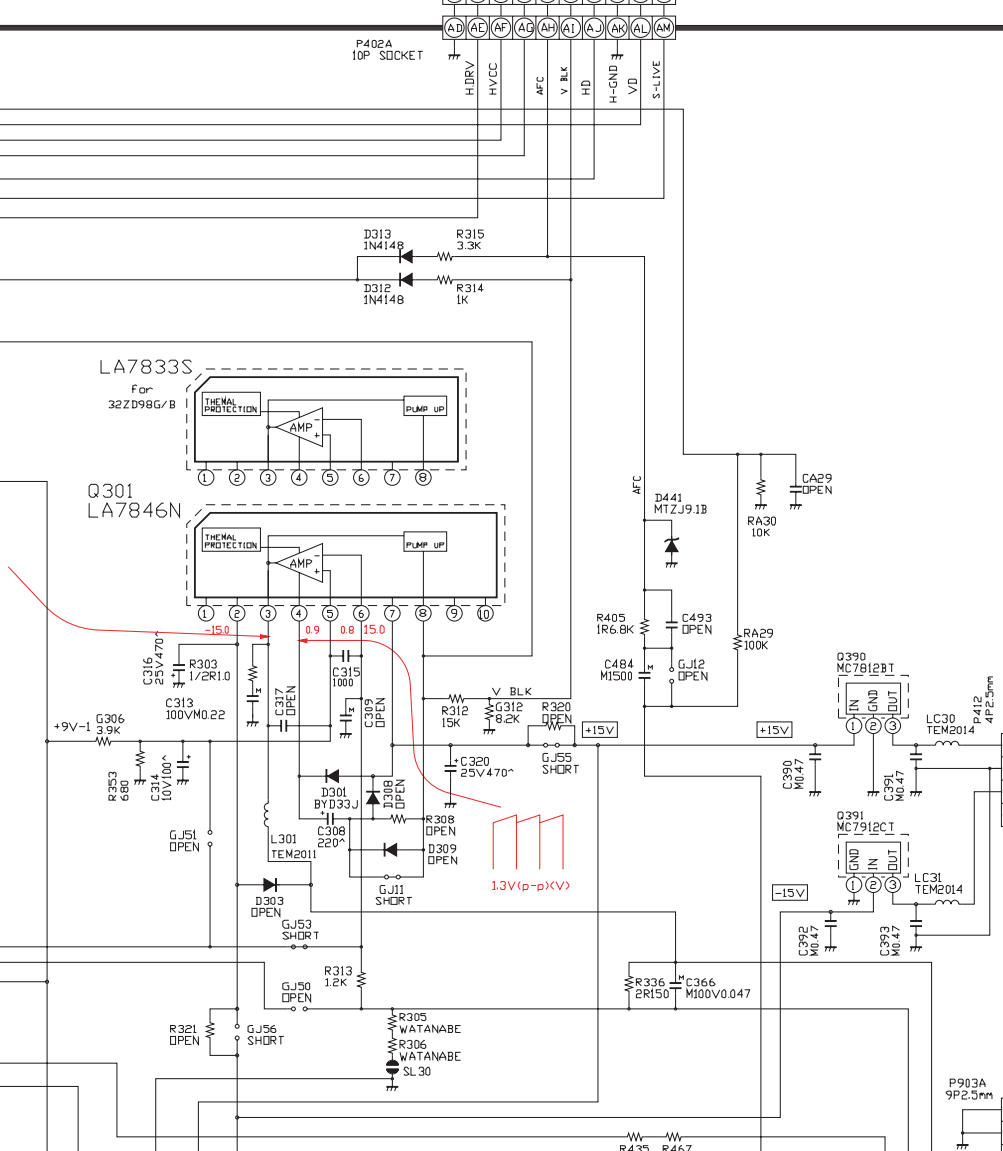

D

E

F

M903

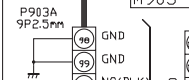

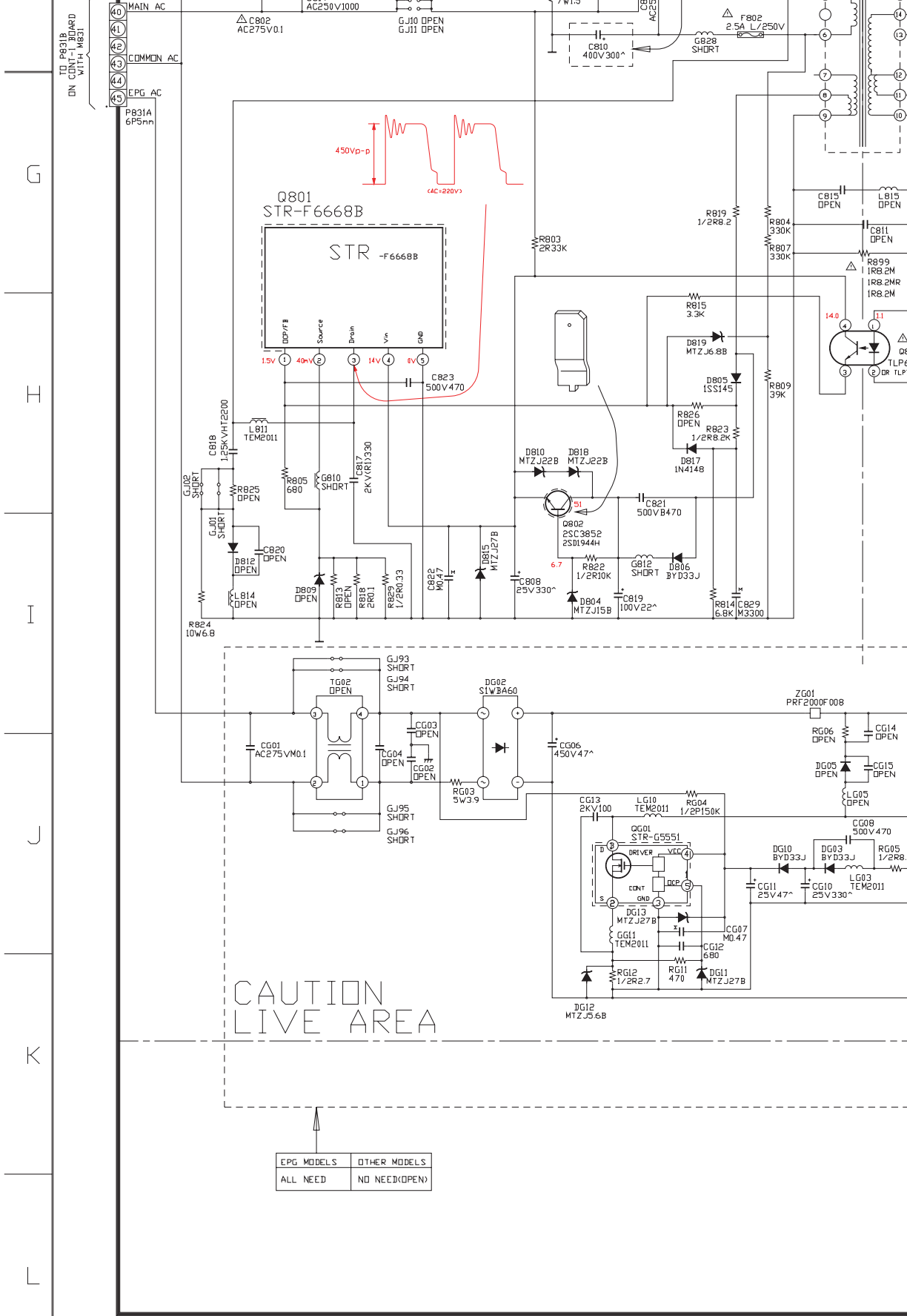

CAUTION  
LIVE AREA

EPG MODELS	OTHER MODELS
ALL NEED	NO NEED(OPEN)

1

2

3

4

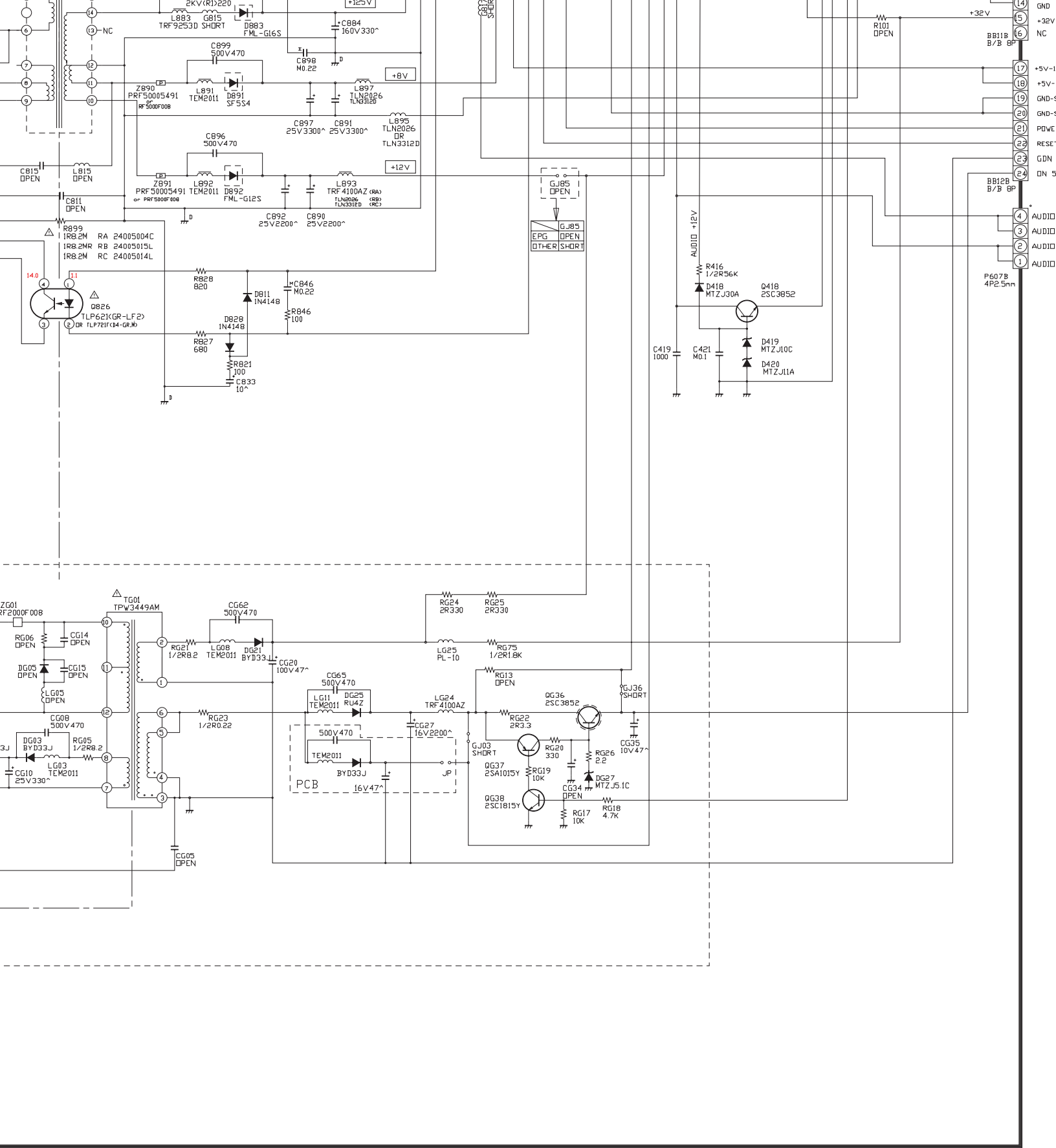

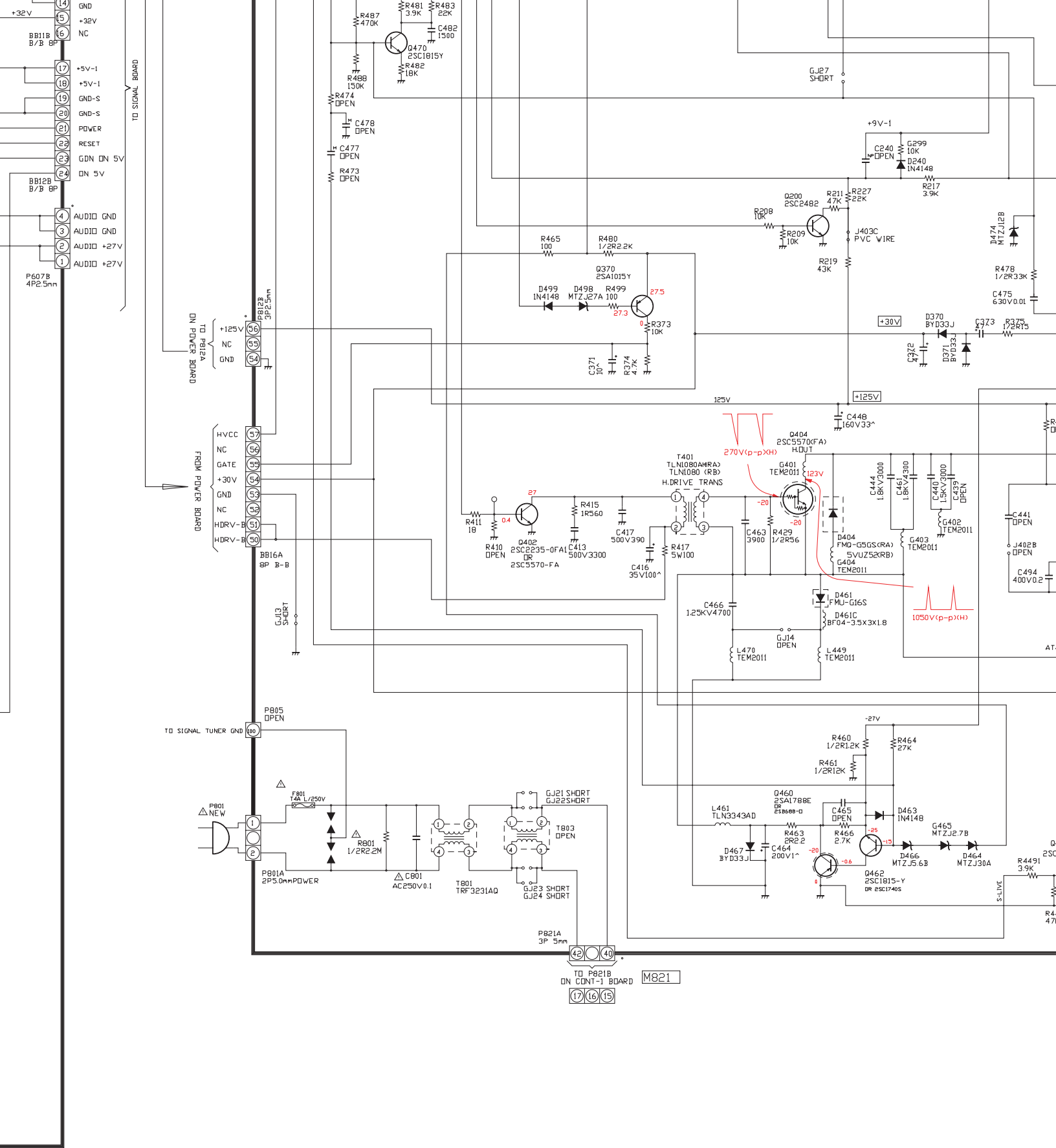

**NOTE**  
 The marking [OPEN] means that there are no component on the PCB though there are the marking of part No. on the PCB. Its means open circuited.

UNIT SN	
POWER	SN.23784883
DEF	SN.23784884
EW100Hz	SN.23784885
	SN.

COPPER SIDE PARTS	
	SN.
	SN.
	SN.
	SN.
	SN.

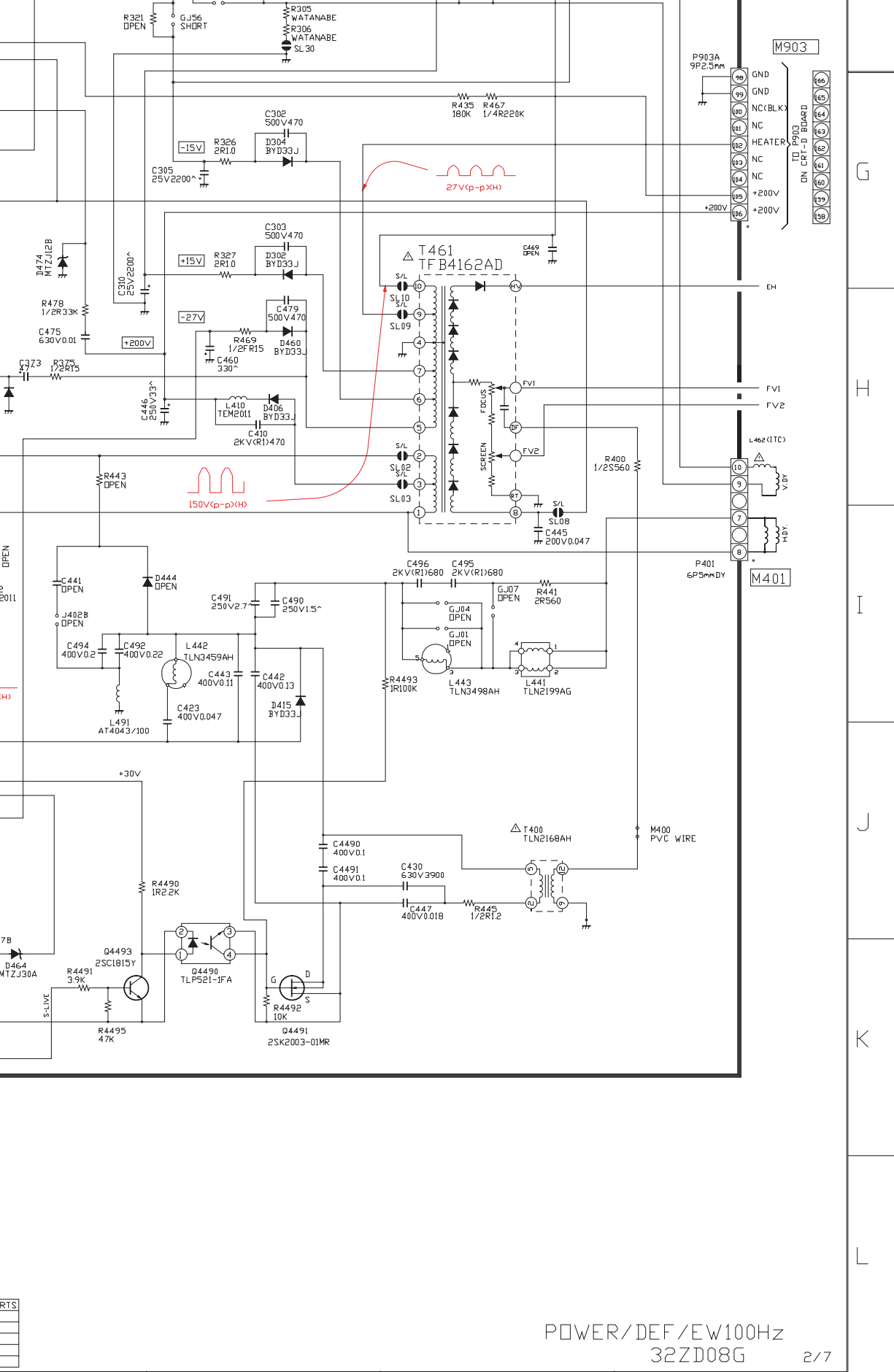

POWER/DEF/EW100Hz  
32ZD08G 2/7

13 14 15 16

RTS

G

H

I

J

K

L



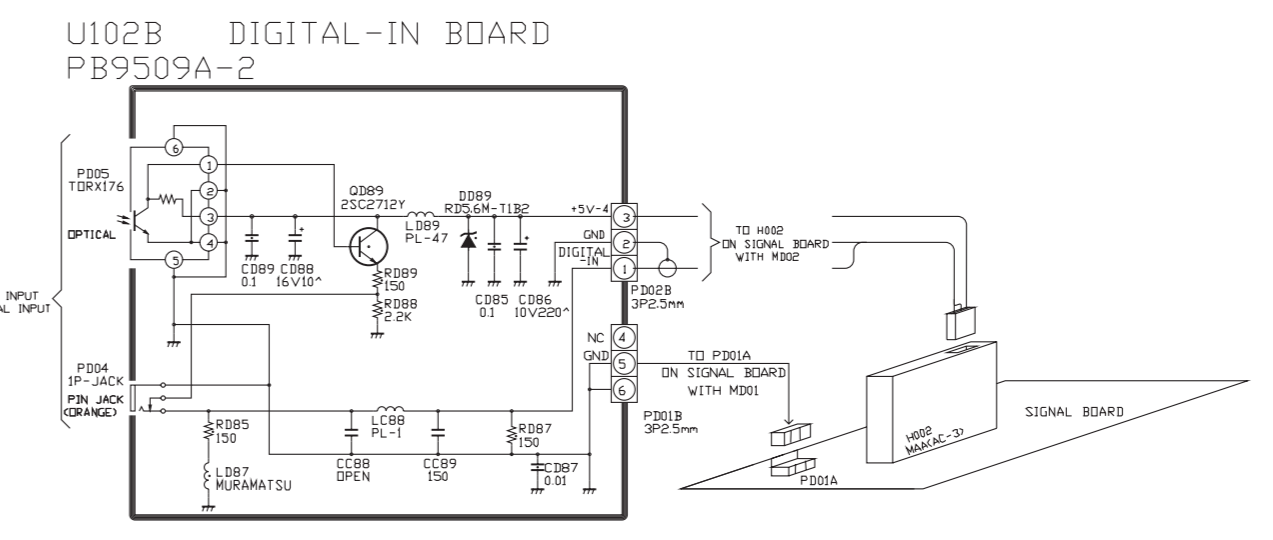
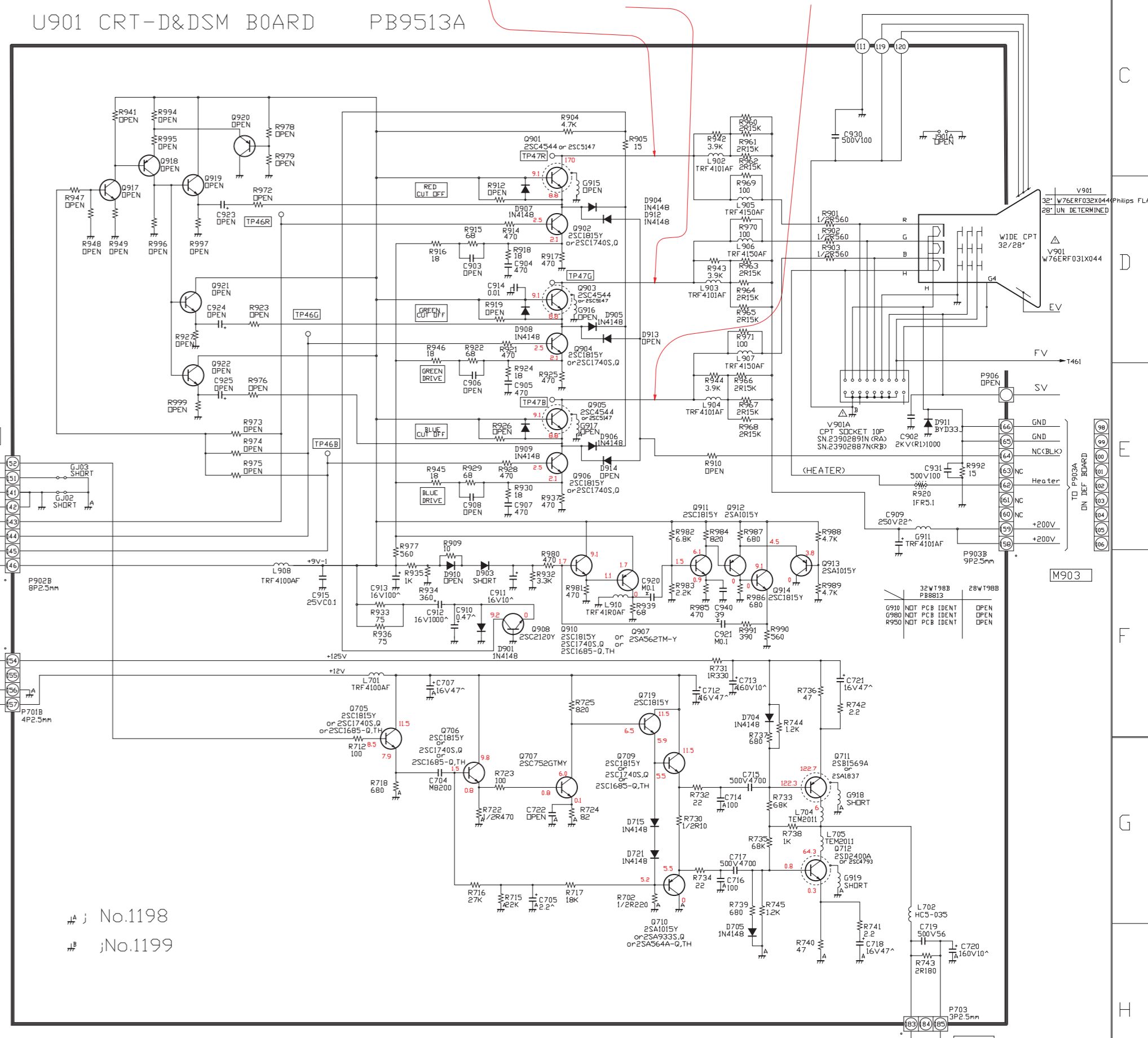
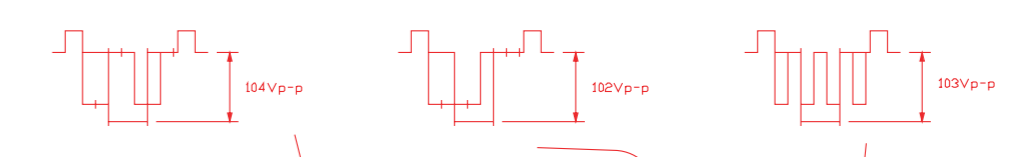
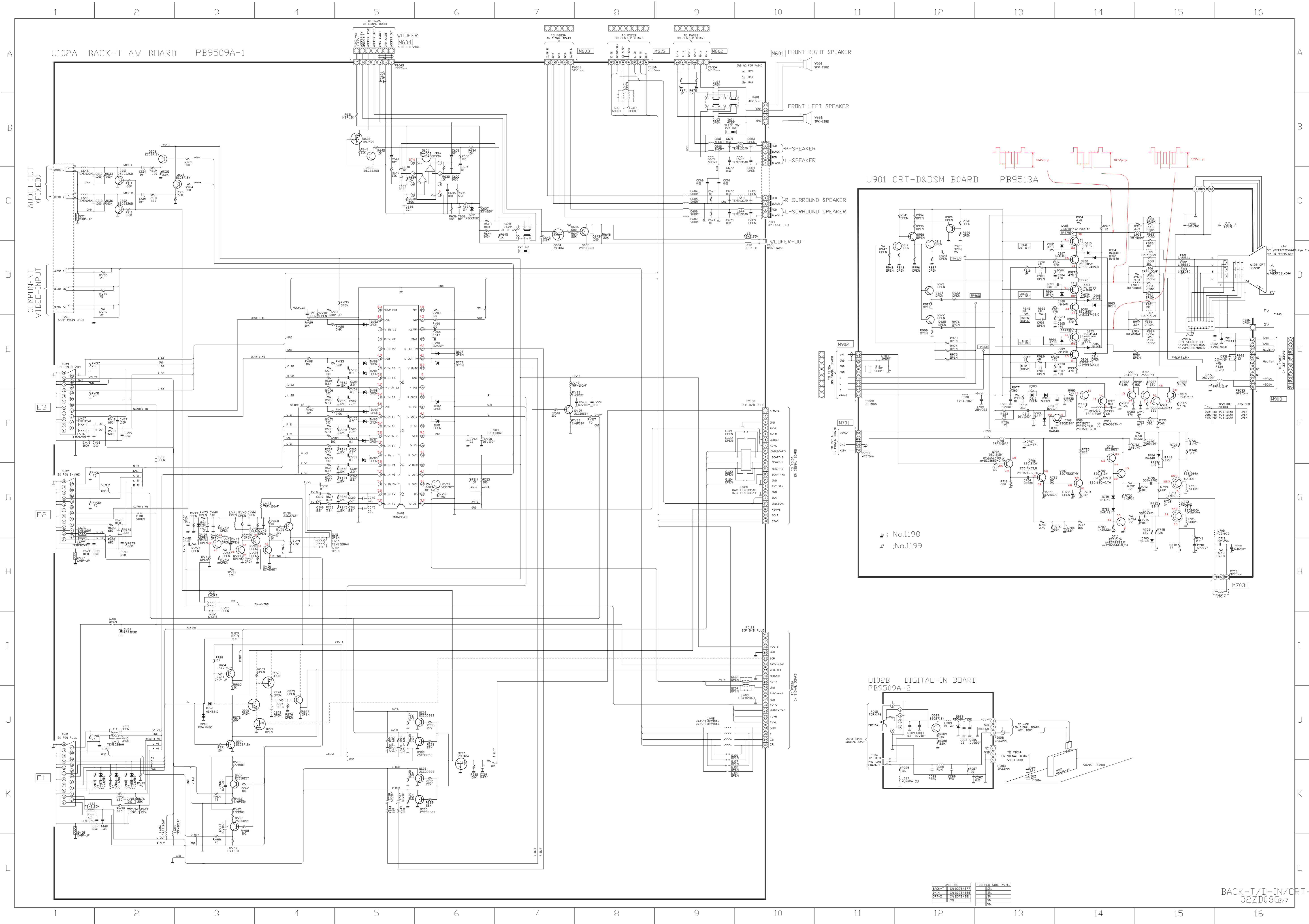

UNIT SN	COPPER SIDE PARTS
M601-1 SN.02784881	LN
M602-1 SN.02784881	LN
M603-1 SN.02784881	LN
M604-1 SN.02784881	LN

1

2

3

4

A

# U102A BACK-T AV BOARD PB9509A-1

B

C

D

E

F

AUDIO OUT  
(FIXED)

COMPONENT  
VIDEO-INPUT

E3

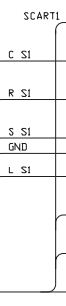
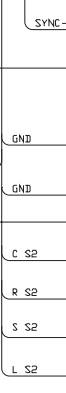
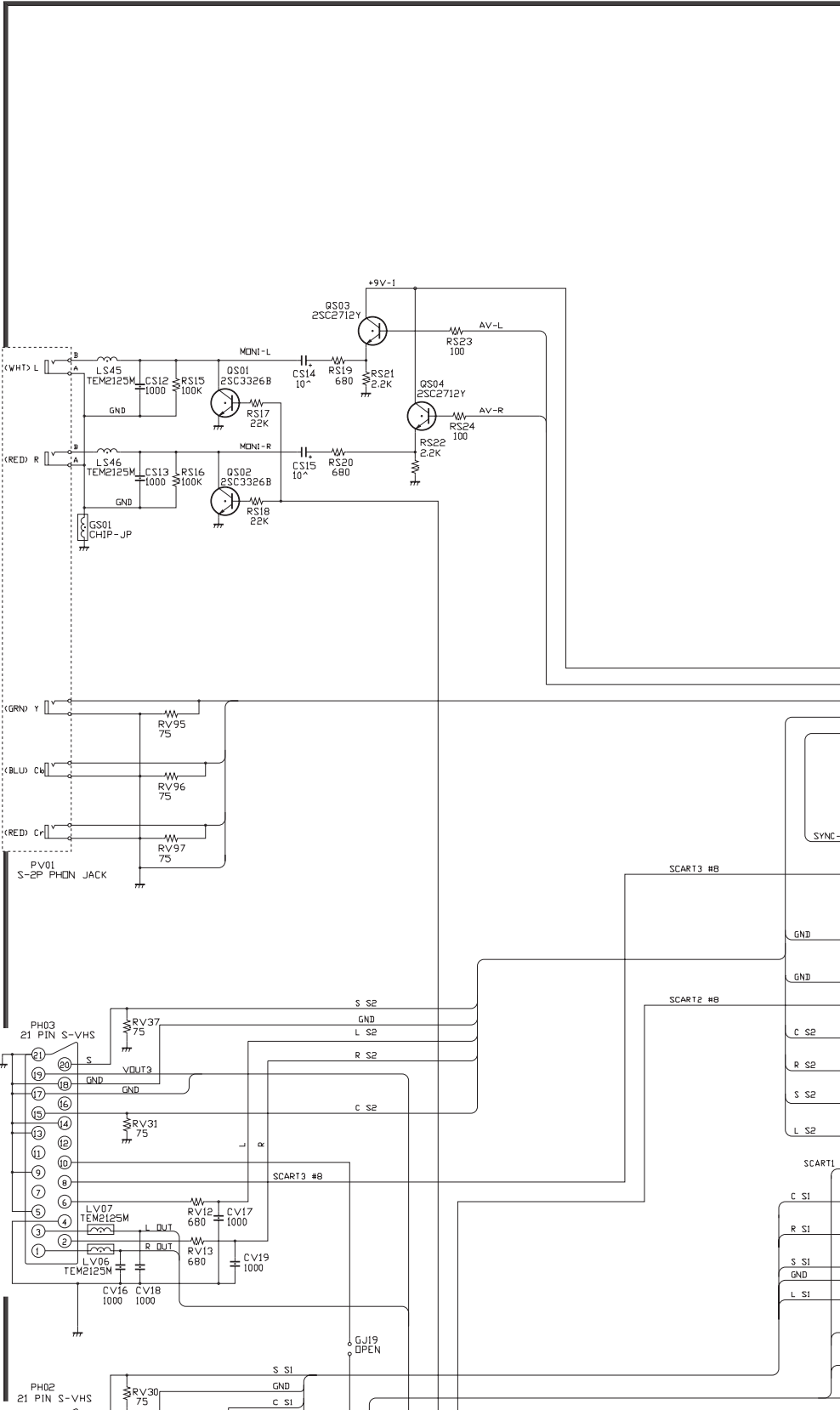

4

5

6

7

8

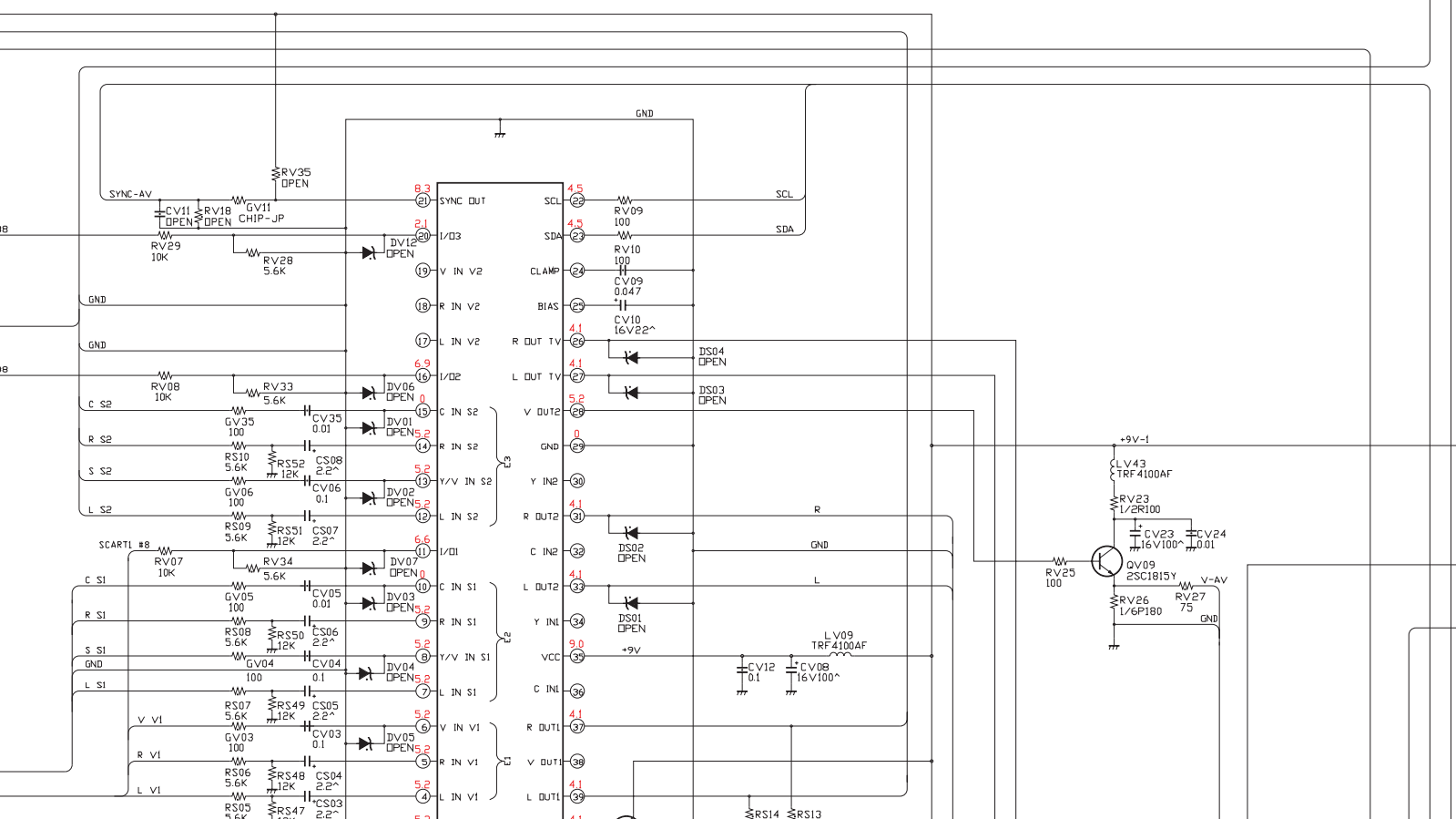
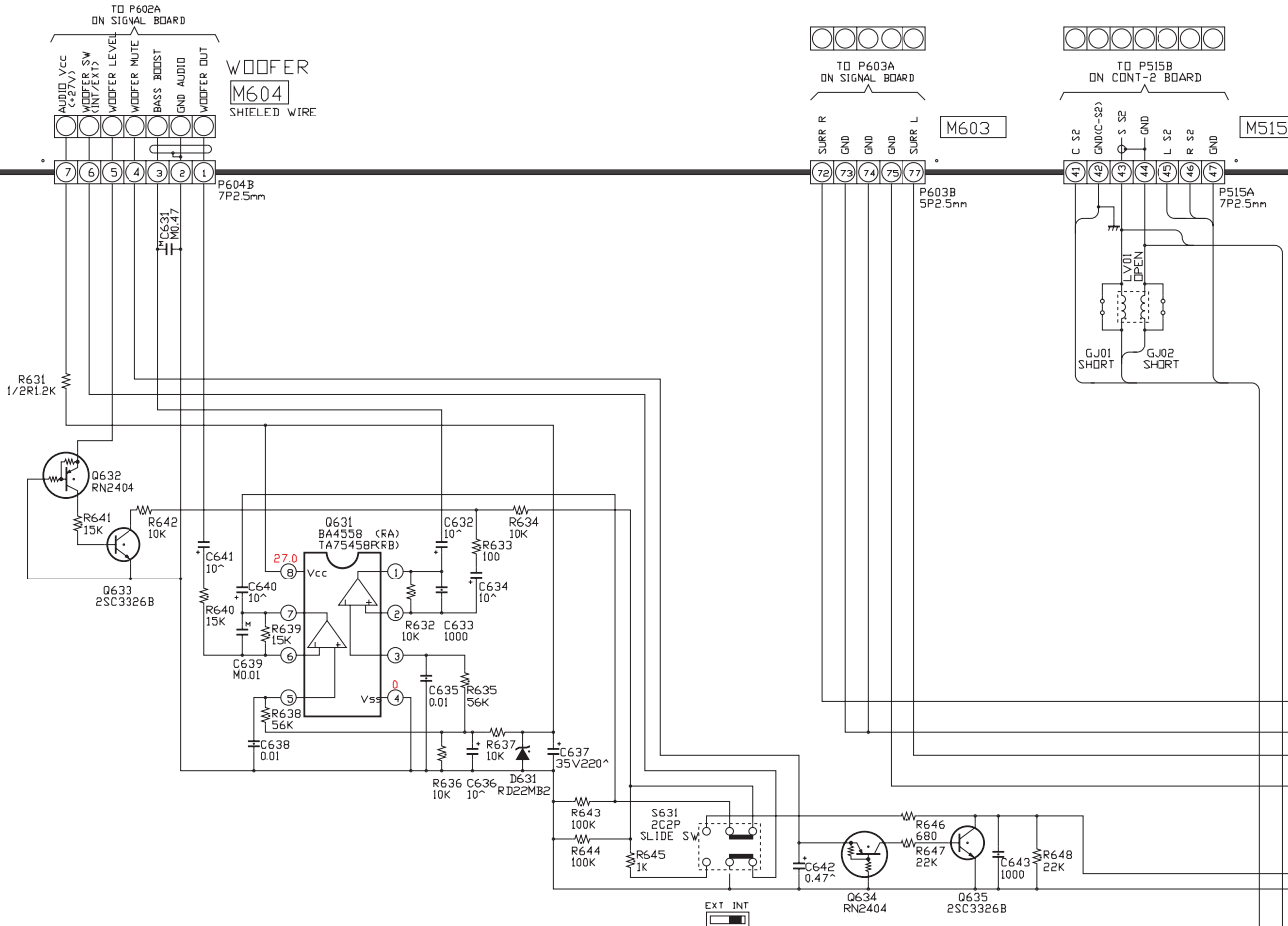

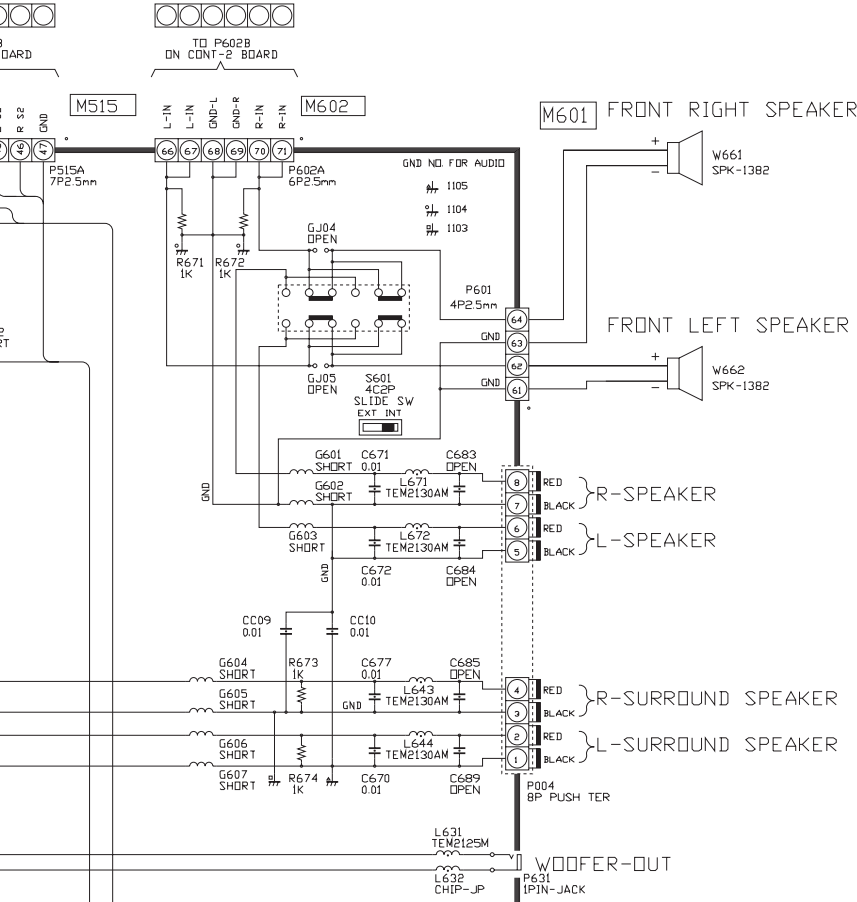

U901 CRT-D&DSM BOARD

PB9513A

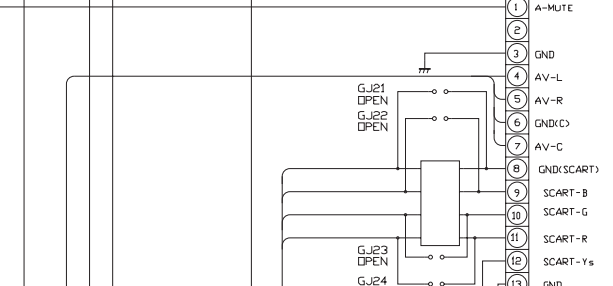
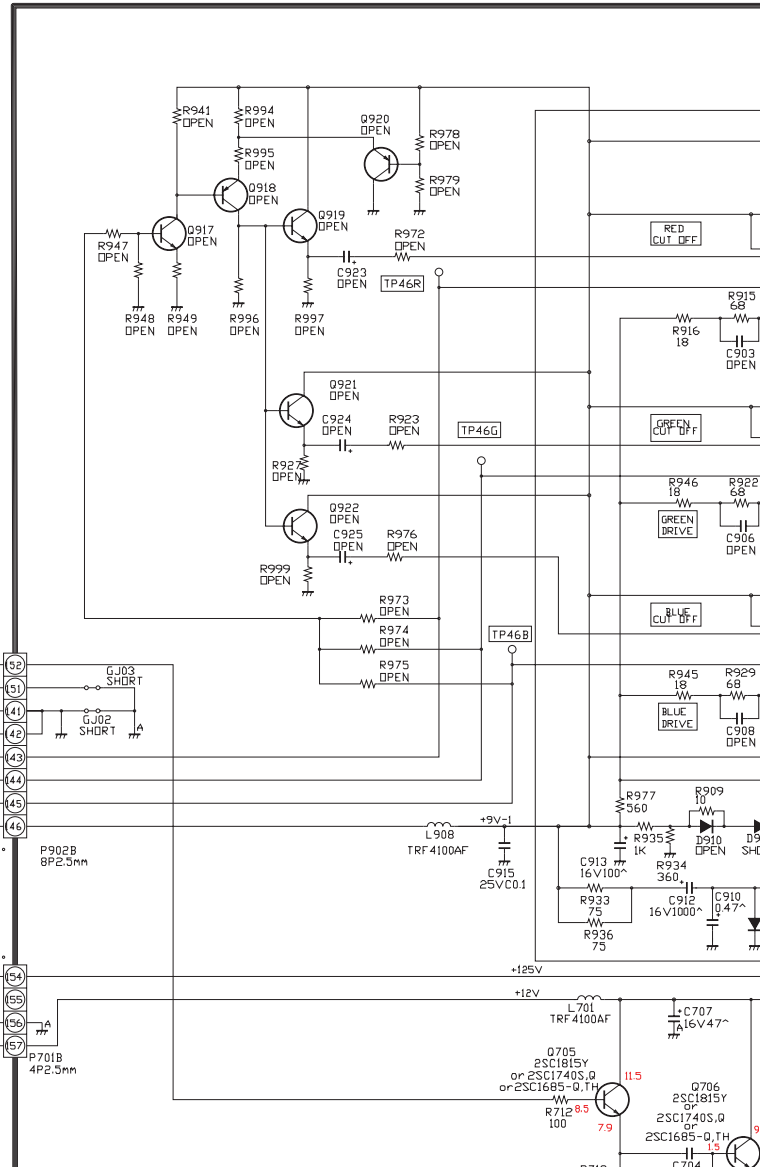
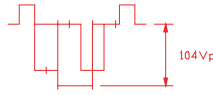

A

B

C

D

E

F

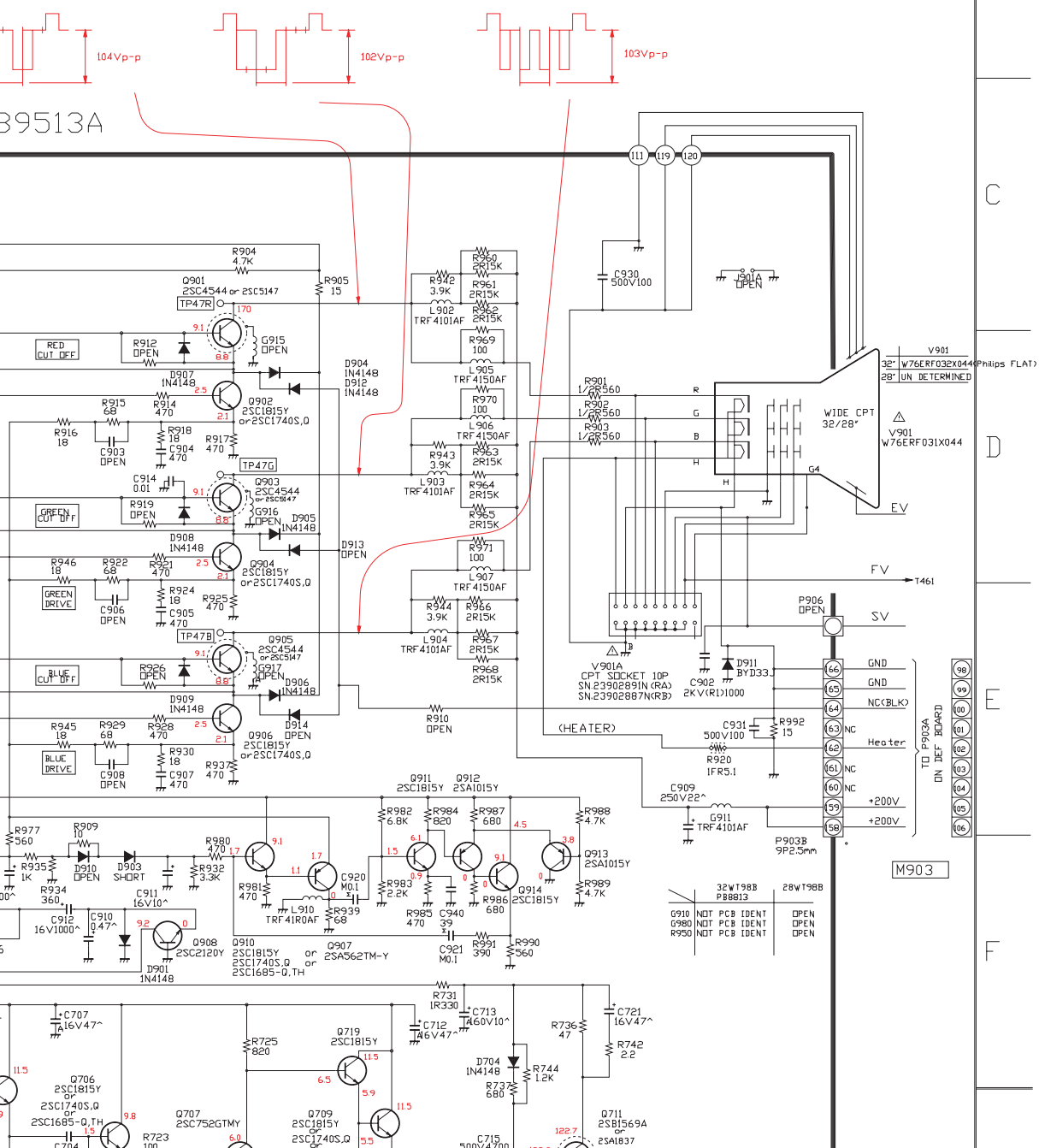

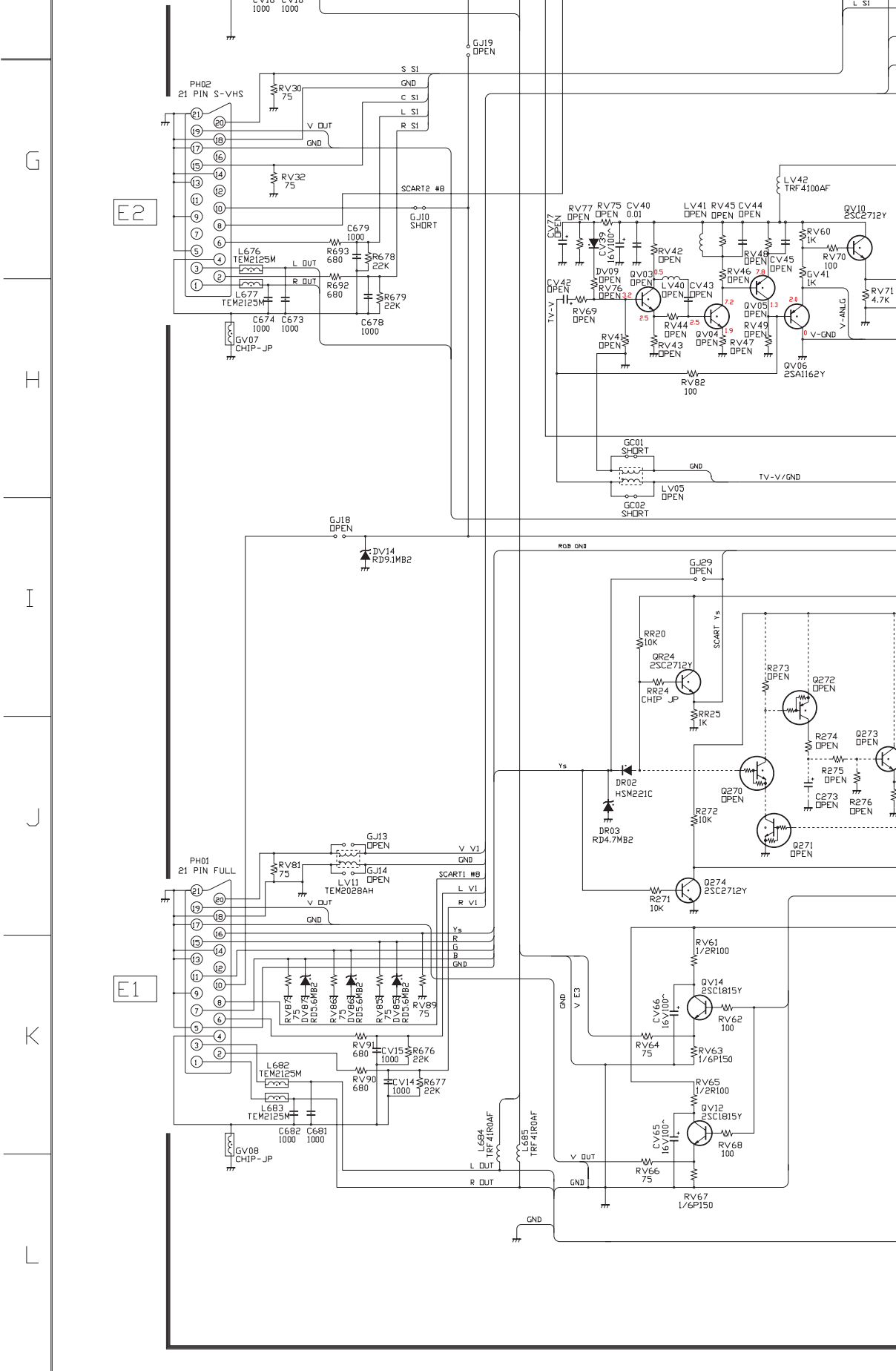

1

2

3

4

G

H

I

J

K

L

E2

E1

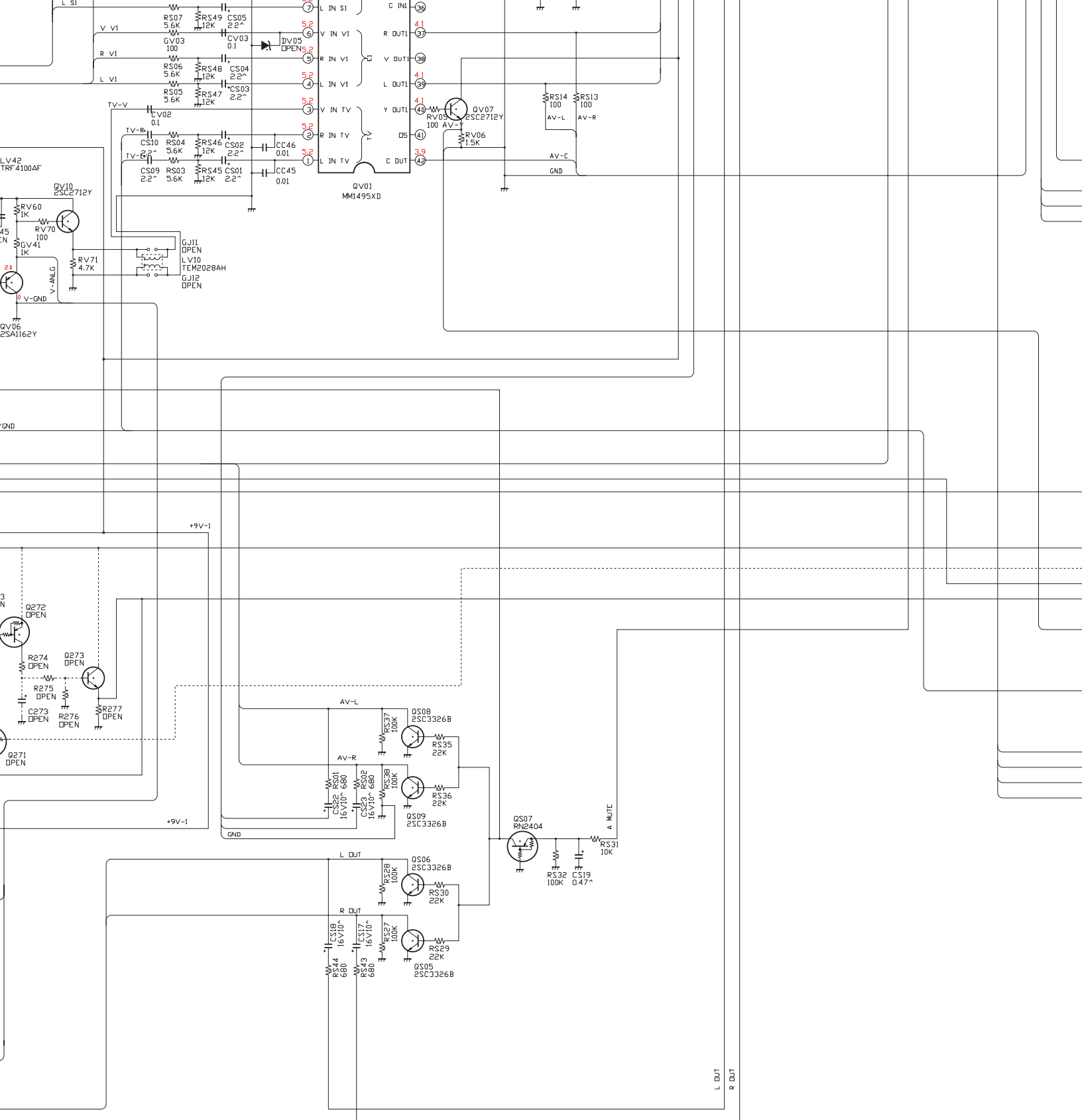

4

5

6

7

8

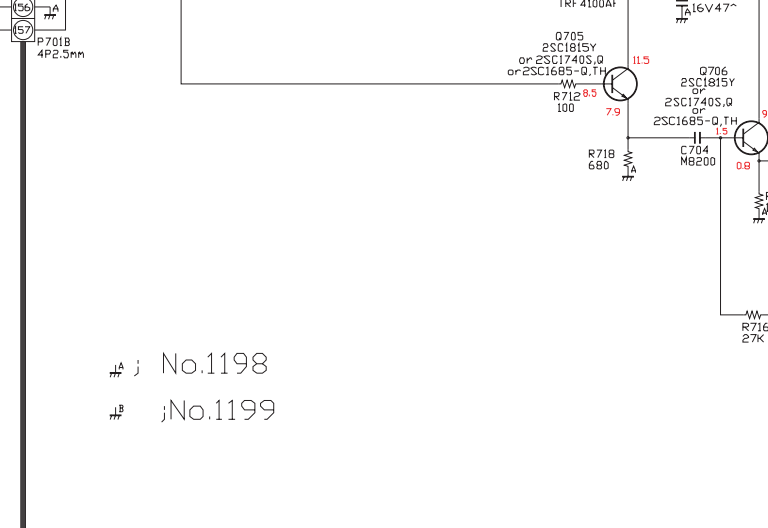
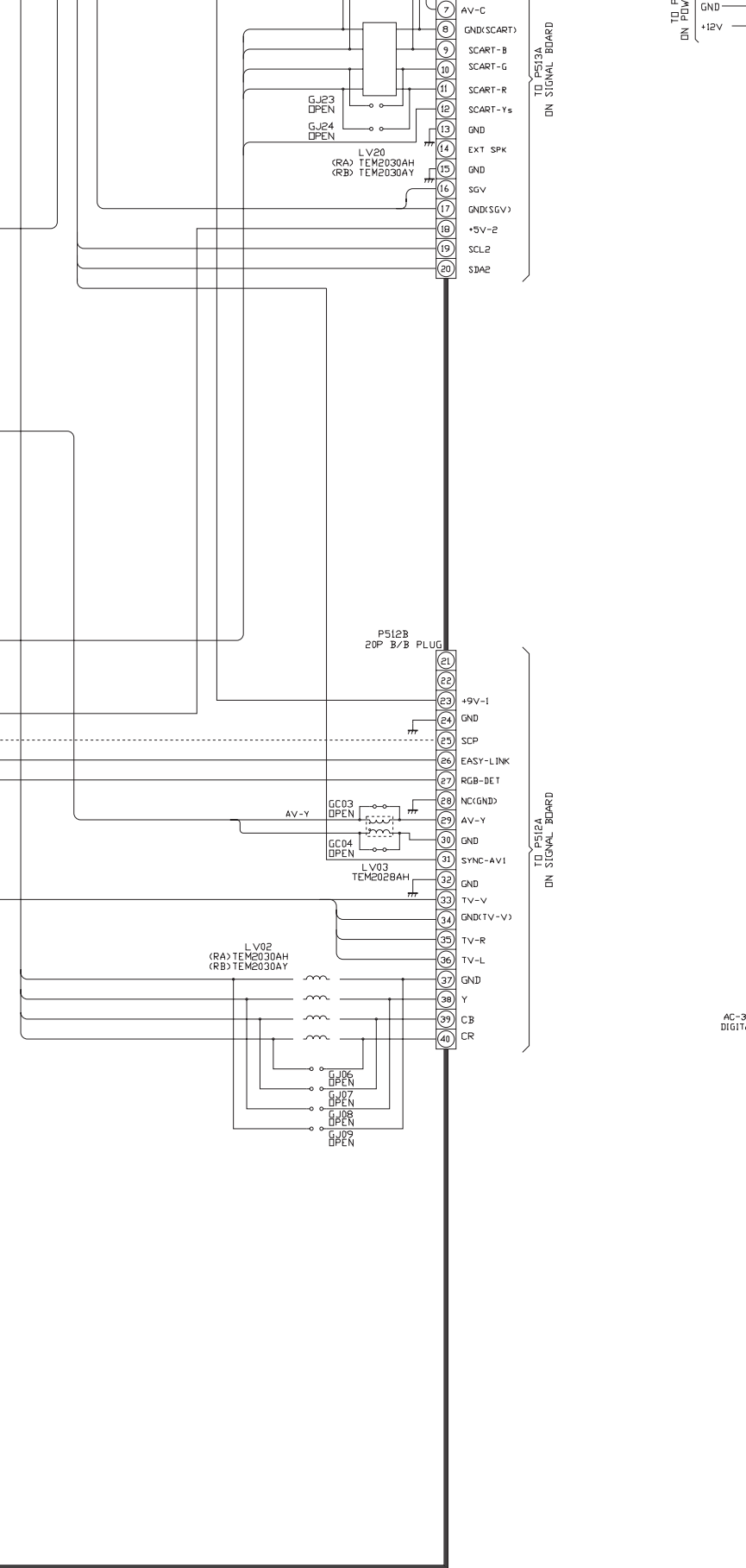

#A ; No.1198  
 #B ; No.1199

### U102B DIGITAL-IN BOARD PB9509A-2

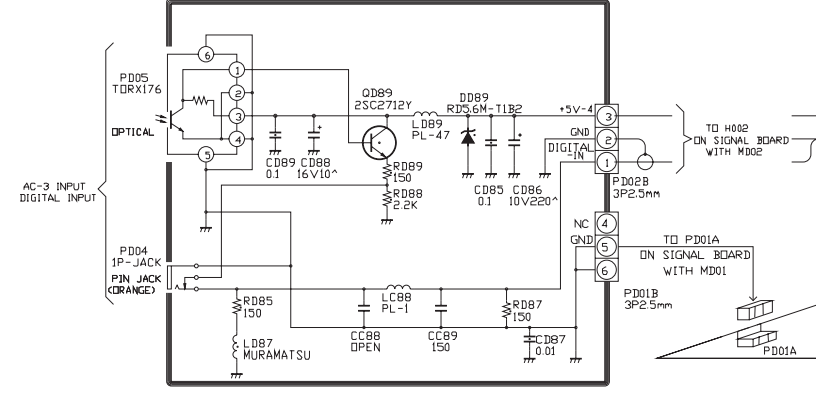

UNIT SN	
BACK-T	SN.23784877
D-IN	SN.23784888
CRT-D	SN.23784881
	SN.

COPPER SIDE PARTS	
	SN.
	SN.
	SN.
	SN.

9

10

11

12

13



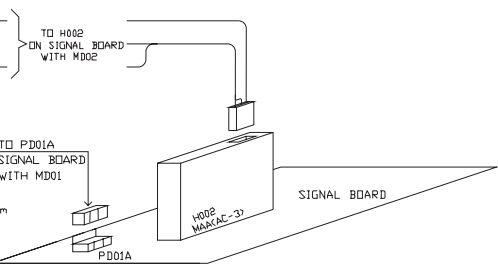
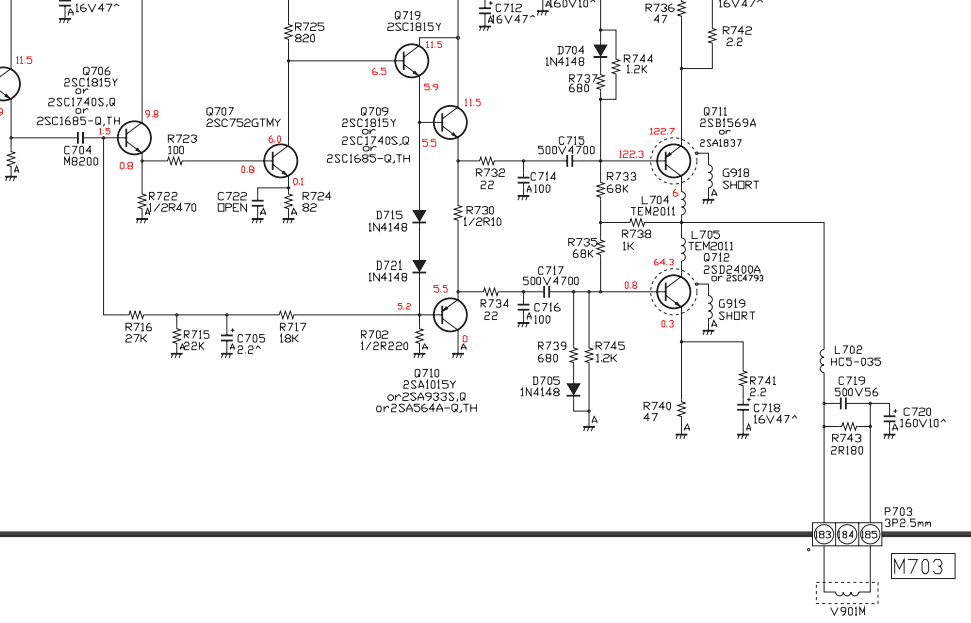

G

H

I

J

K

L

BACK-T/D-IN/CRT-D  
32ZD08G<sub>3/7</sub>

13                      14                      15                      16

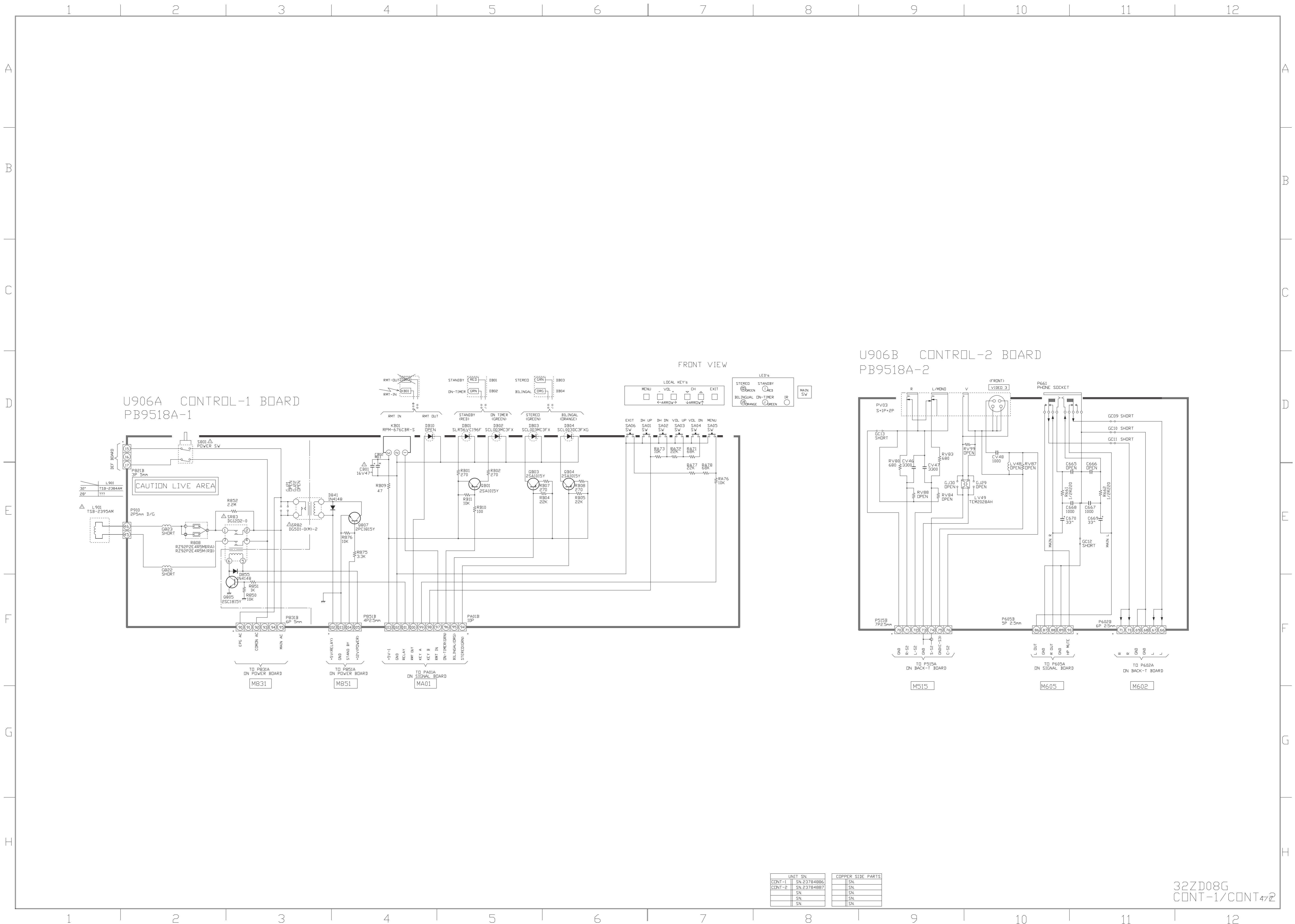

U906A CONTROL-1 BOARD  
PB9518A-1

FRONT VIEW

U906B CONTROL-2 BOARD  
PB9518A-2

UNIT SN		COPPER SIDE PARTS	
CONT-1	SN.23784886		SN.
CONT-2	SN.23784887		SN.
	SN.		SN.
	SN.		SN.

32ZD08G  
CONT-1/CONT47Z

1

2

3

A

B

C

D

# U906A CONTROL-1 BOARD PB9518A-1

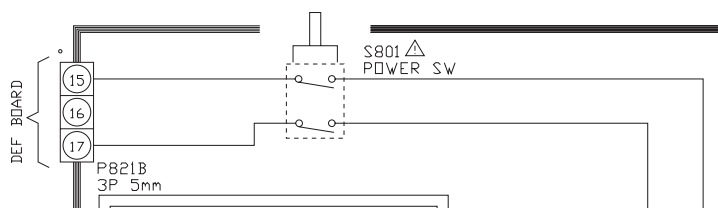

3

4

5

6

BOARD

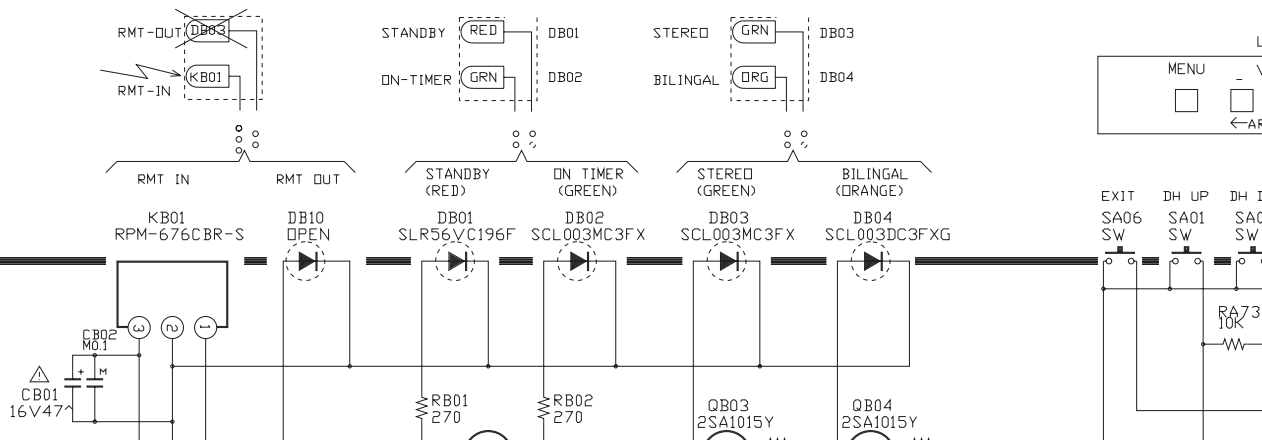

FRONT VIEW

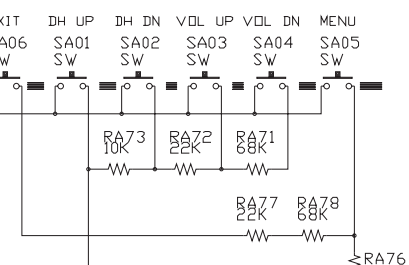
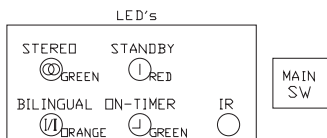
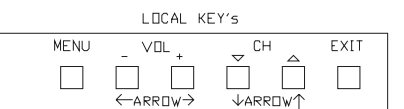

U906B CONTROL-2 BOARD  
PB9518A-2

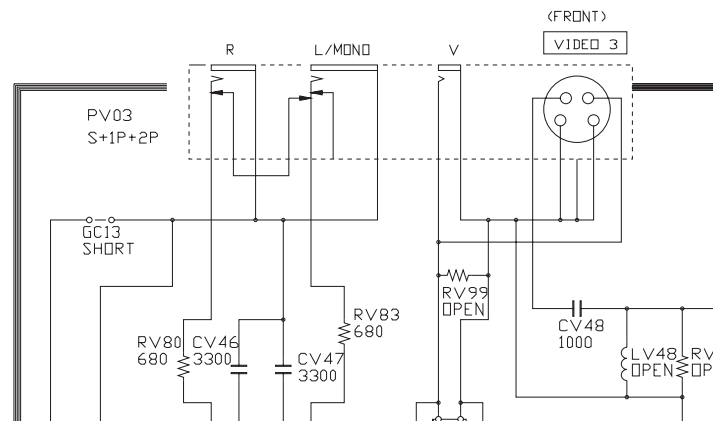

10

11

12

A

B

C

D

BOARD

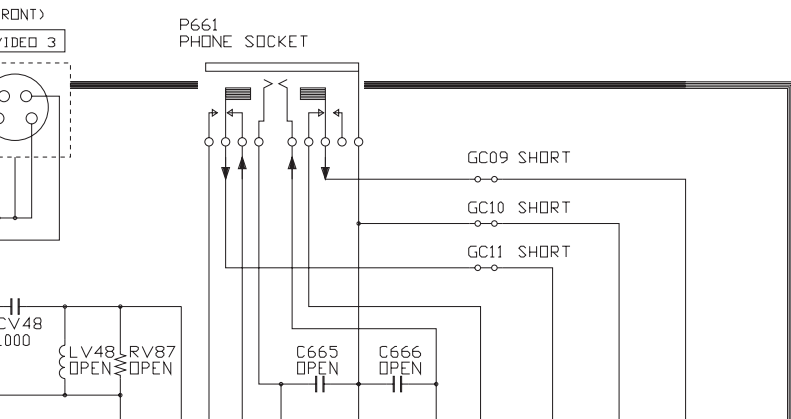

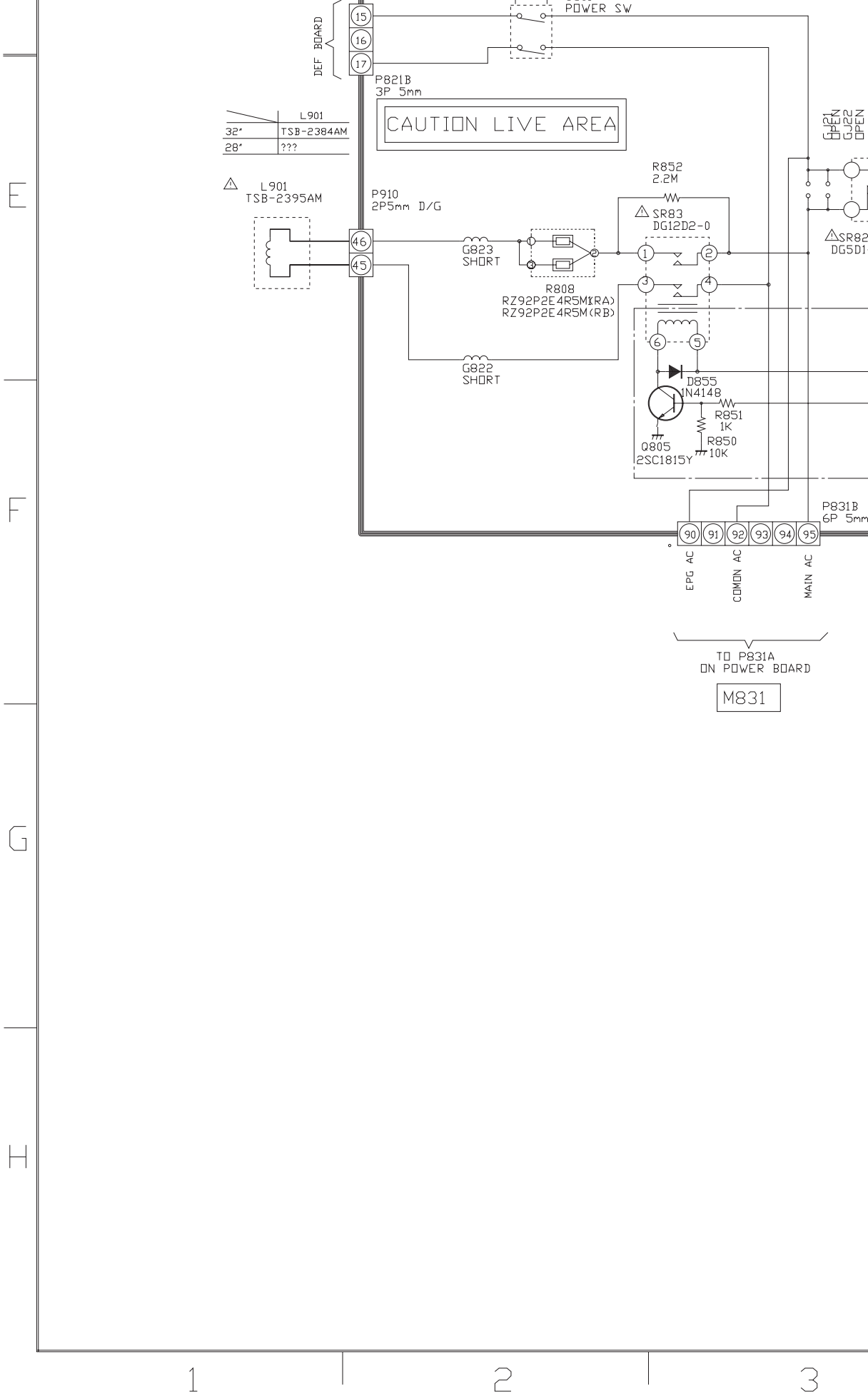

E

F

G

H

1

2

3

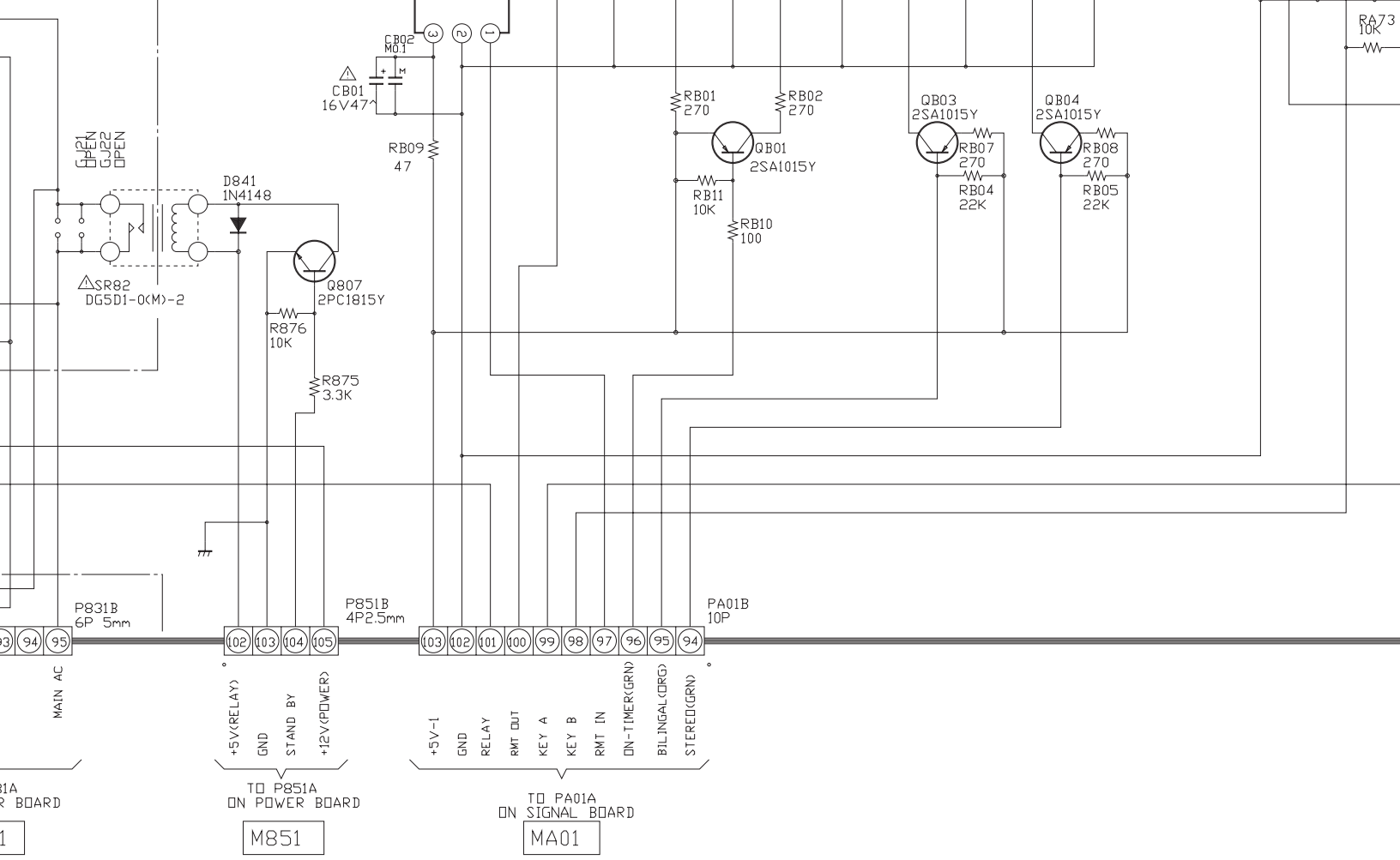



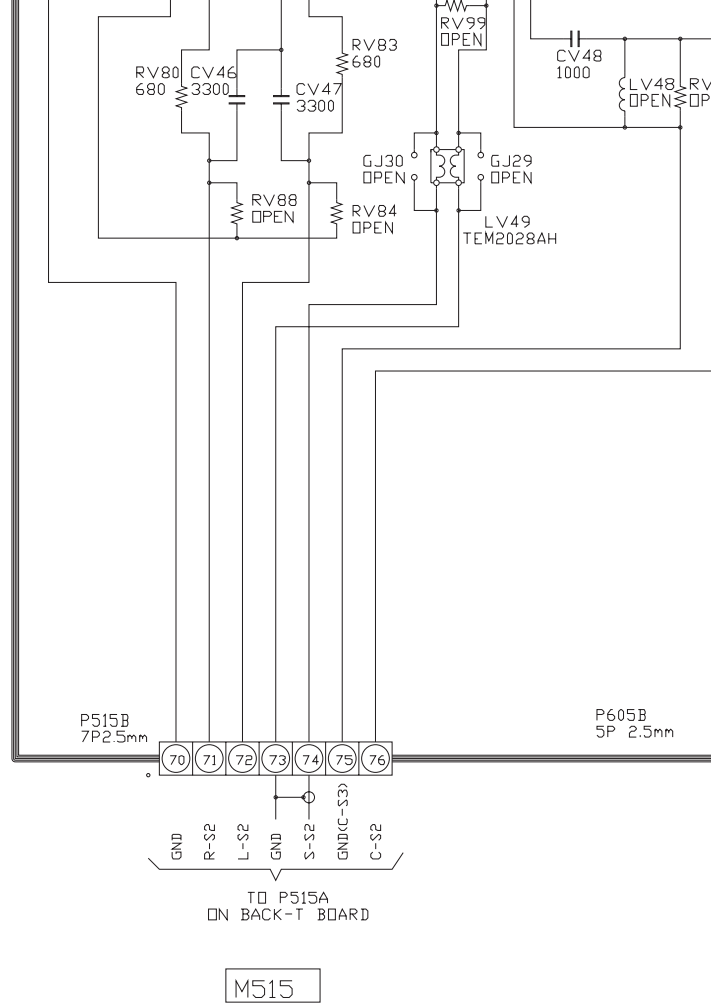
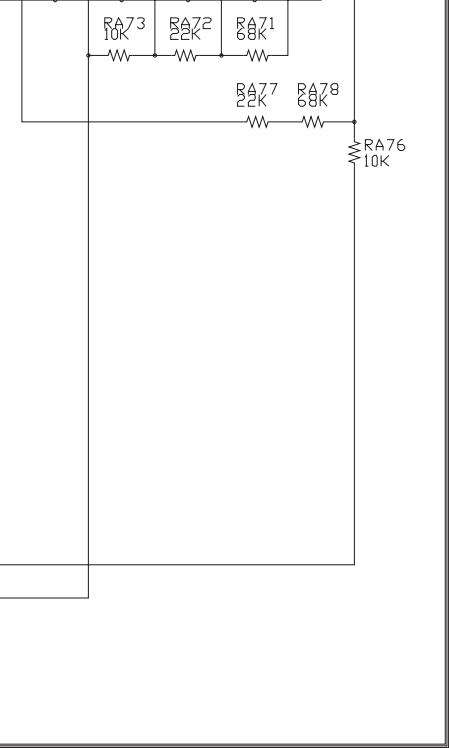

M515

UNIT SN.	
CONT-1	SN.23784886
CONT-2	SN.23784887
	SN.
	SN.
	SN.

COPPER SIDE PARTS	
	SN.
	SN.
	SN.
	SN.
	SN.

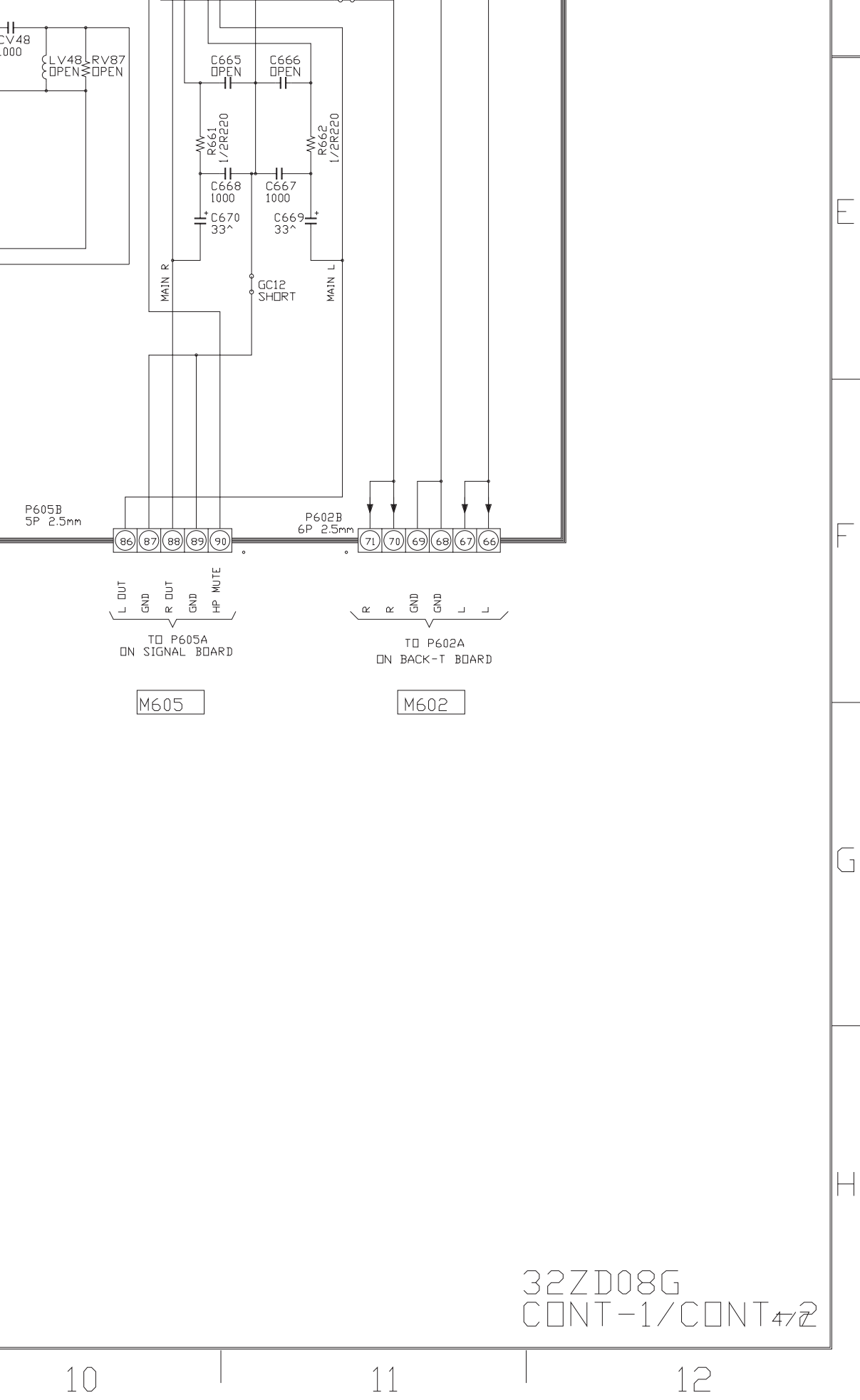

32ZD08G  
CONT-1/CONT<sub>472</sub>

10

11

12

U105 DFS BOARD(Ver4)B9512A

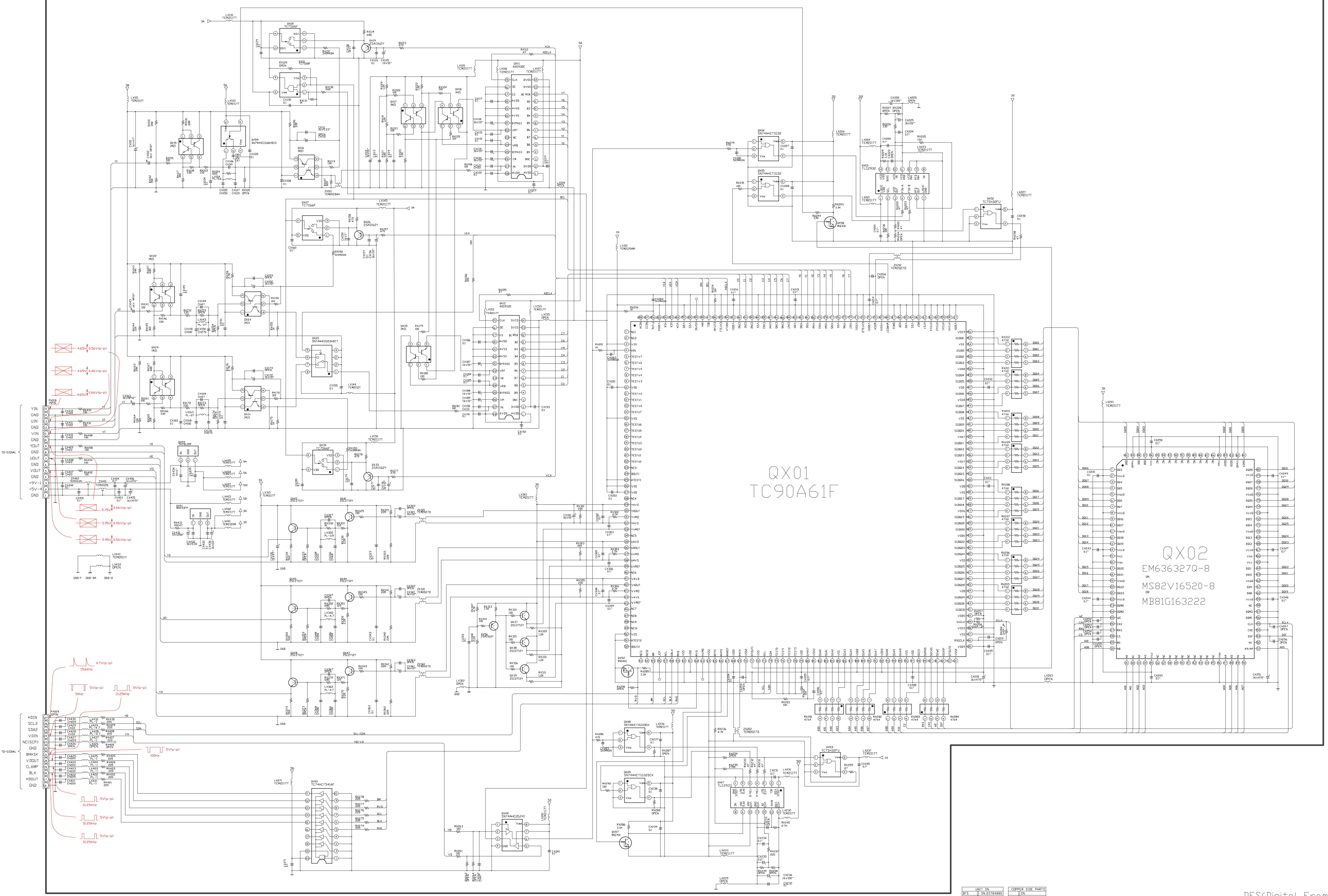

QX01  
TC90A61F

QX02  
EM636327Q-8  
MS82V16520-8  
MB81G163222

UNIT	SN	COPPER SIDE	PARTS
DF-1	SN 23744800	1/1	1/1
DF-2	SN	1/1	1/1
DF-3	SN	1/1	1/1
DF-4	SN	1/1	1/1
DF-5	SN	1/1	1/1

1

2

3

4

# U105 DFS BOARD(Ver 4)B

A

B

C

D

E

F

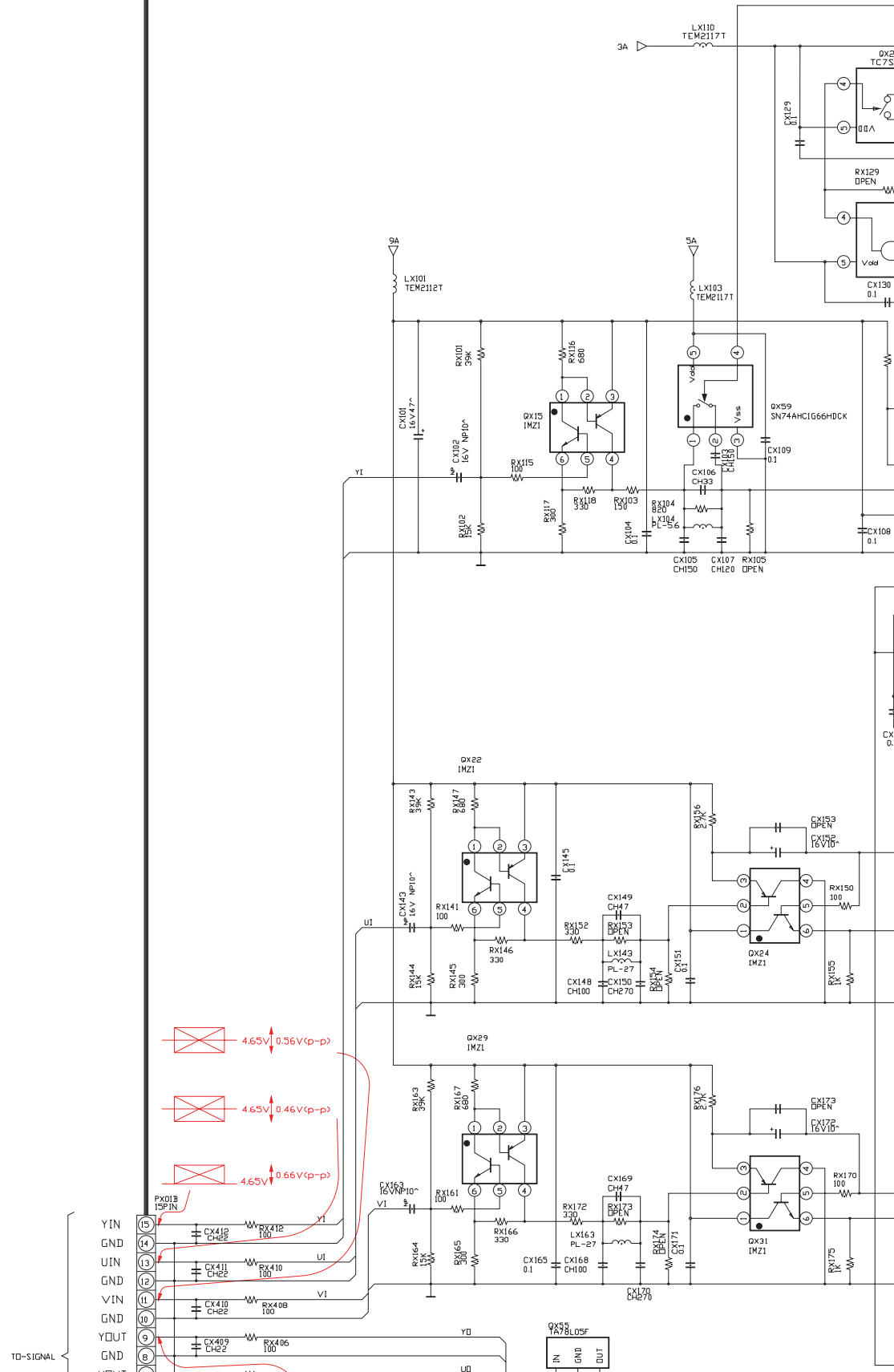

4.65V 0.56V (p-p)

4.65V 0.46V (p-p)

4.65V 0.66V (p-p)

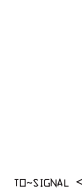

# 49B9512A

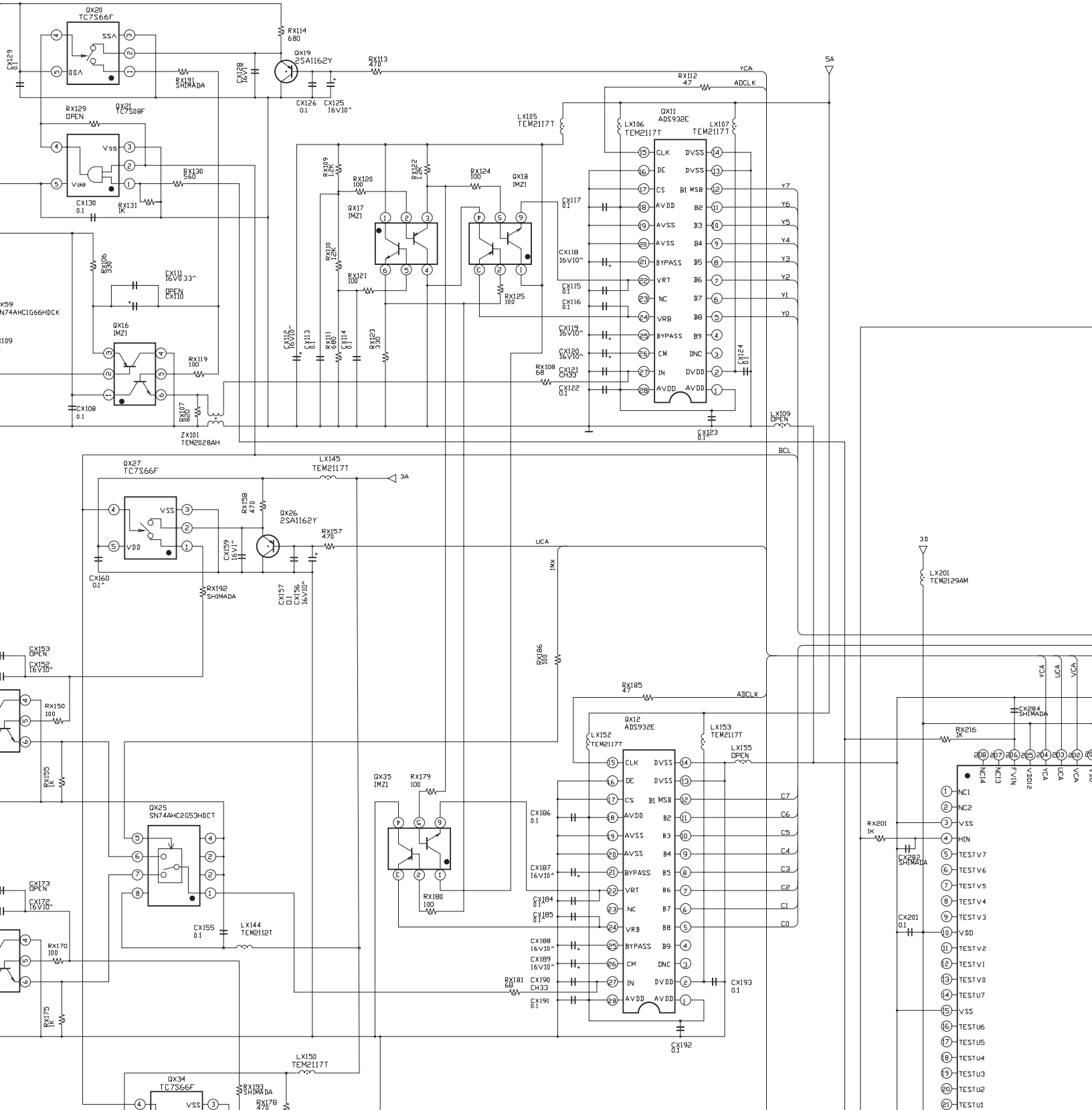



13

14

15

16

A

B

C

D

E

F

200  
201  
202  
203  
204  
205  
206  
207  
208  
209  
210  
211  
212  
213

3D  
LX241  
TEM2117T

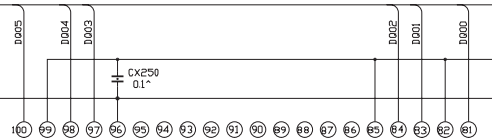

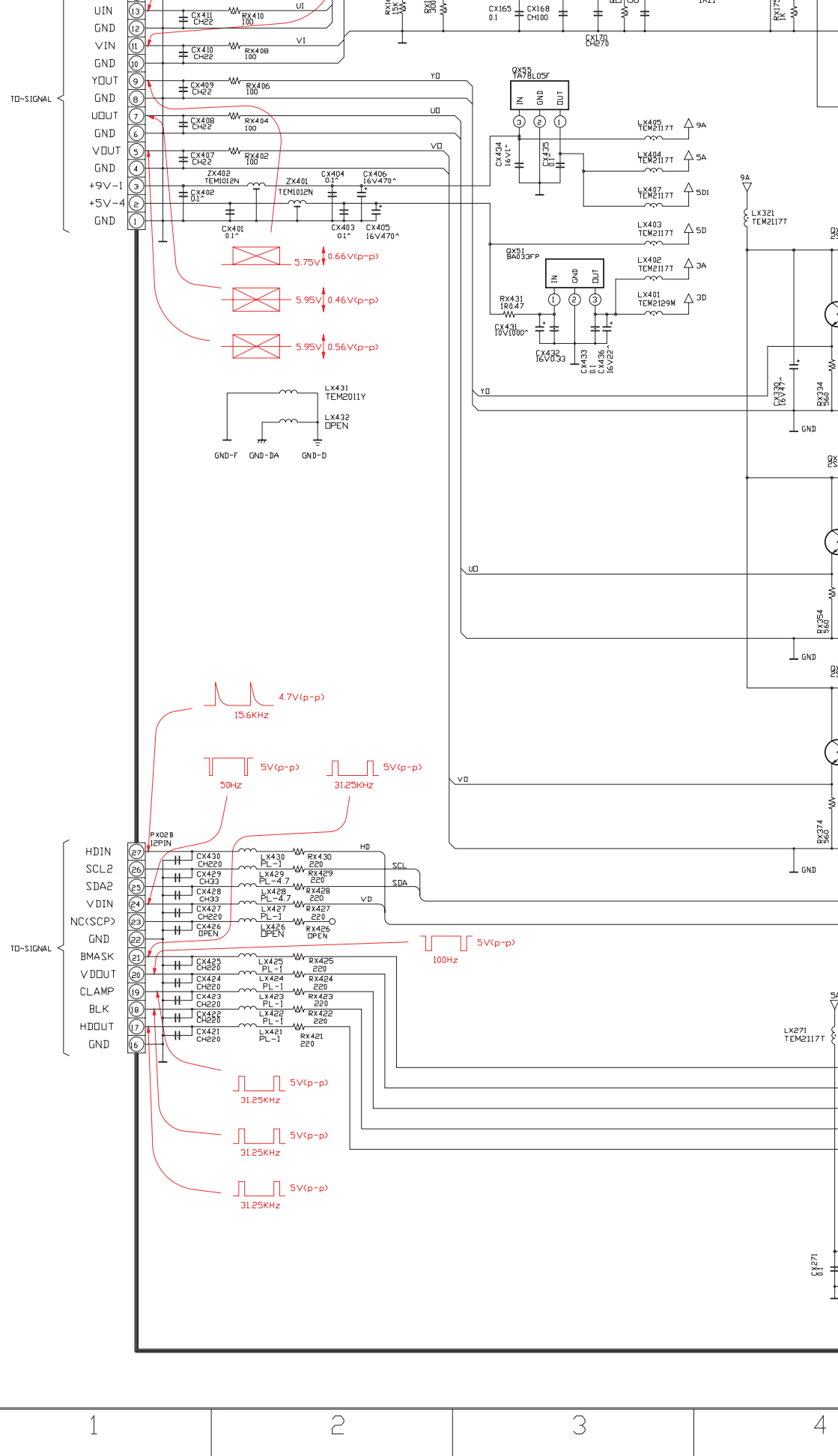



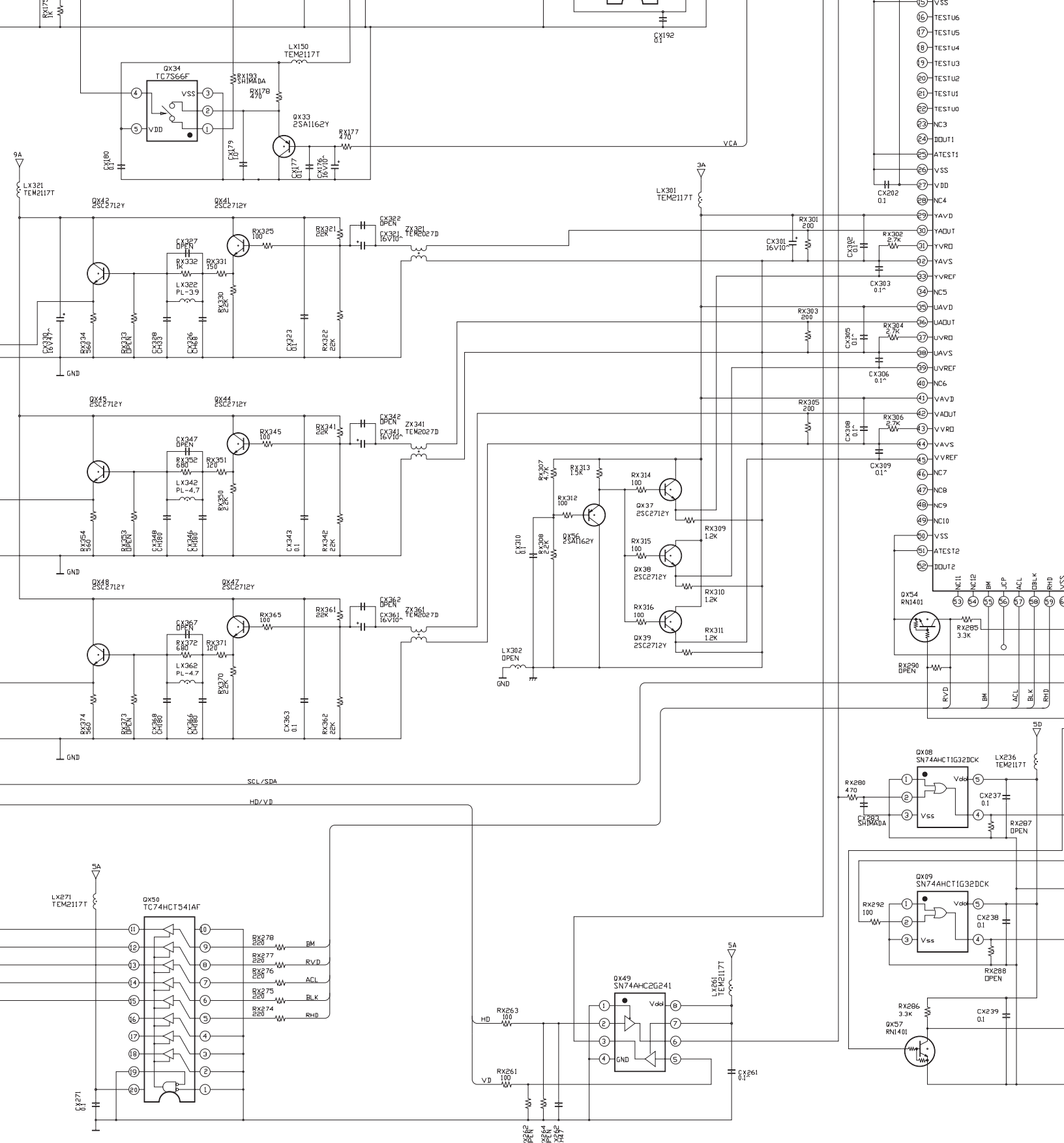

# QX01 TC90A61F

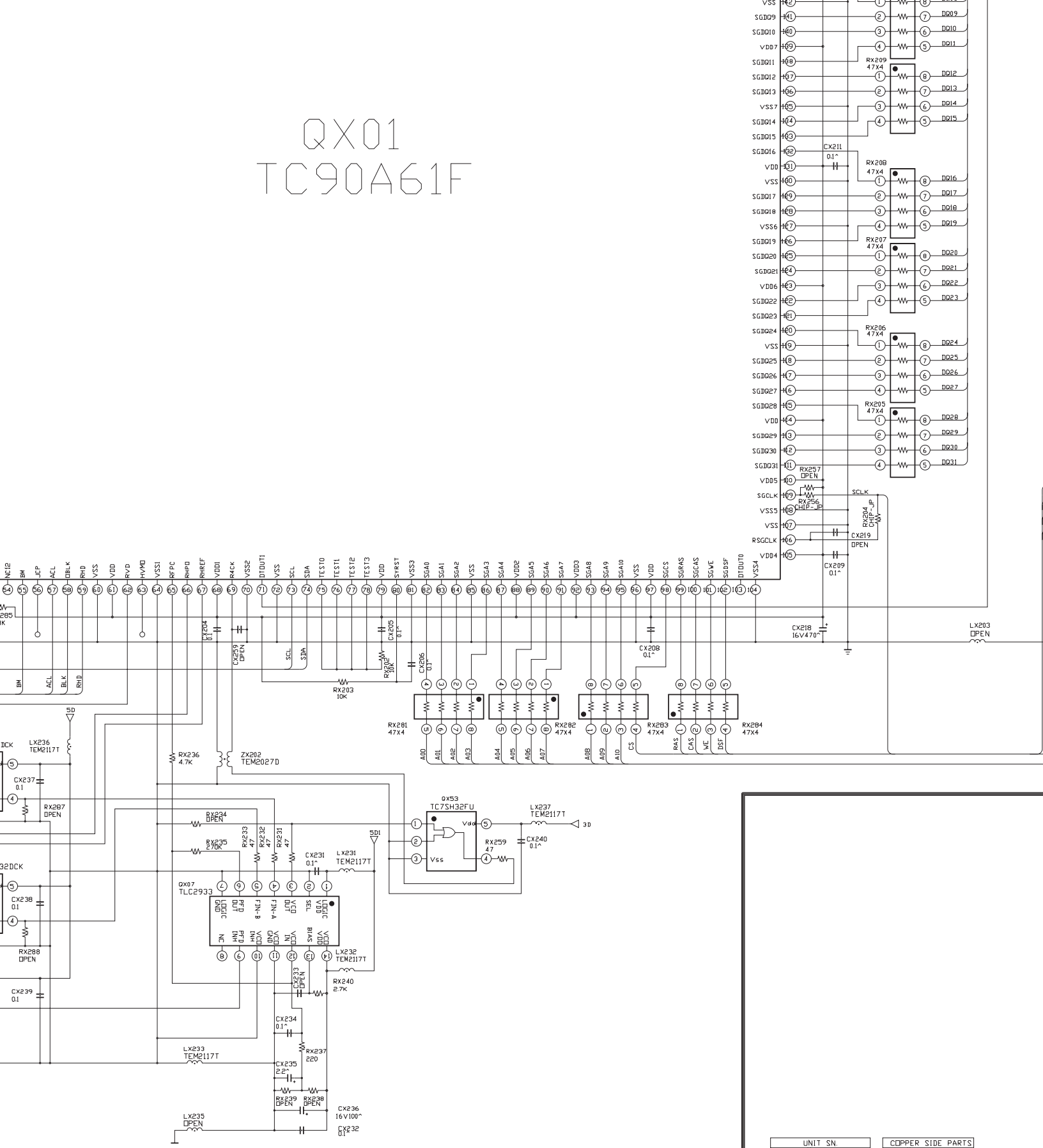

UNIT SN.	
DFS	SN.23784880
	SN.
	SN.
	SN.

COPPER SIDE PARTS	
	SN.
	SN.
	SN.
	SN.

Q19  
Q20  
Q21  
Q22  
Q23  
Q24  
Q25  
Q26  
Q27  
Q28  
Q29  
Q30  
Q31

LX203  
OPEN

PARTS

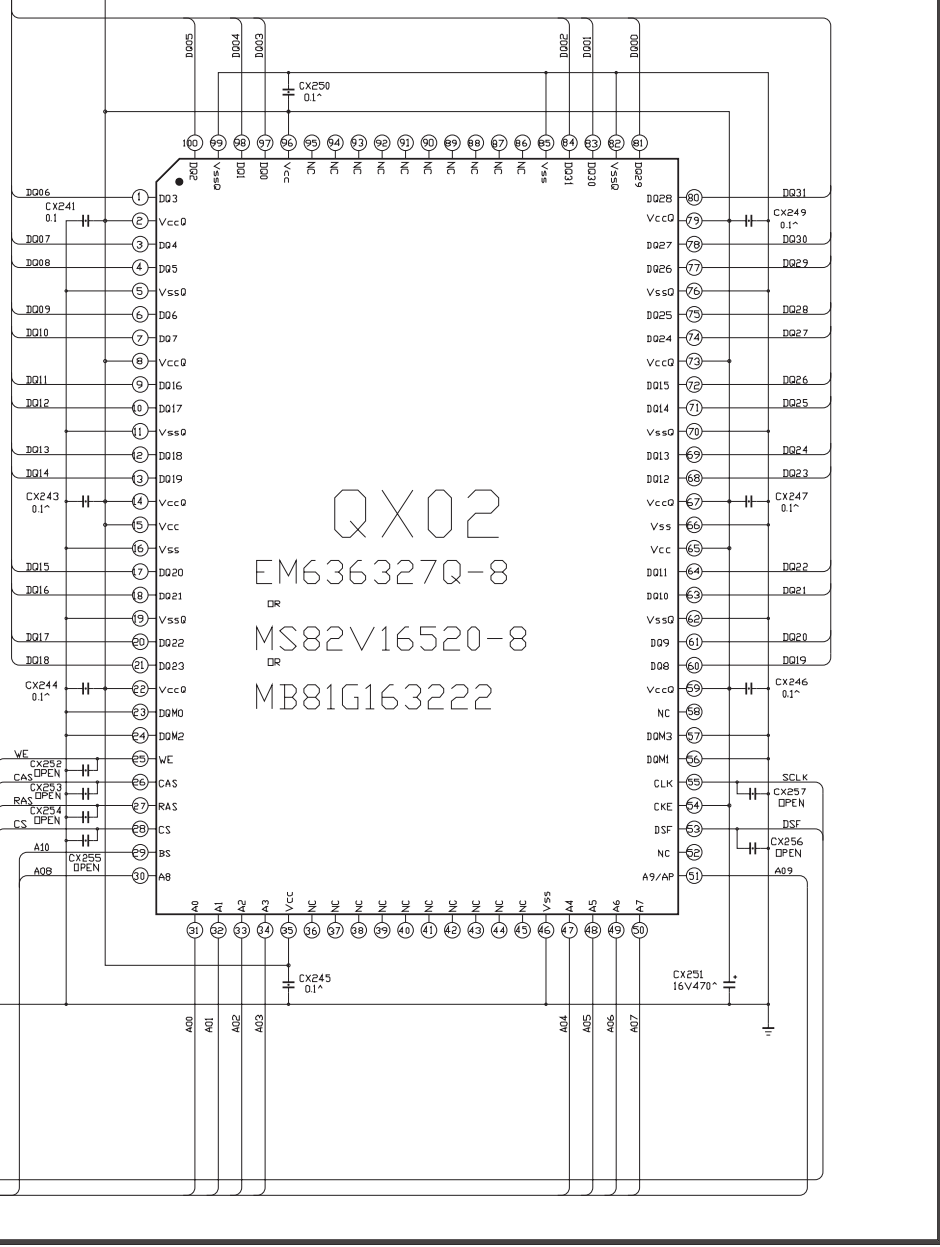

G

H

I

J

K

L

DFS<Digital Frame Scan>  
32ZD08G17

13                      14                      15                      16

U103 D-COMB&MCD BOARD PB 9510A

DIGITAL-COMB-FILTER

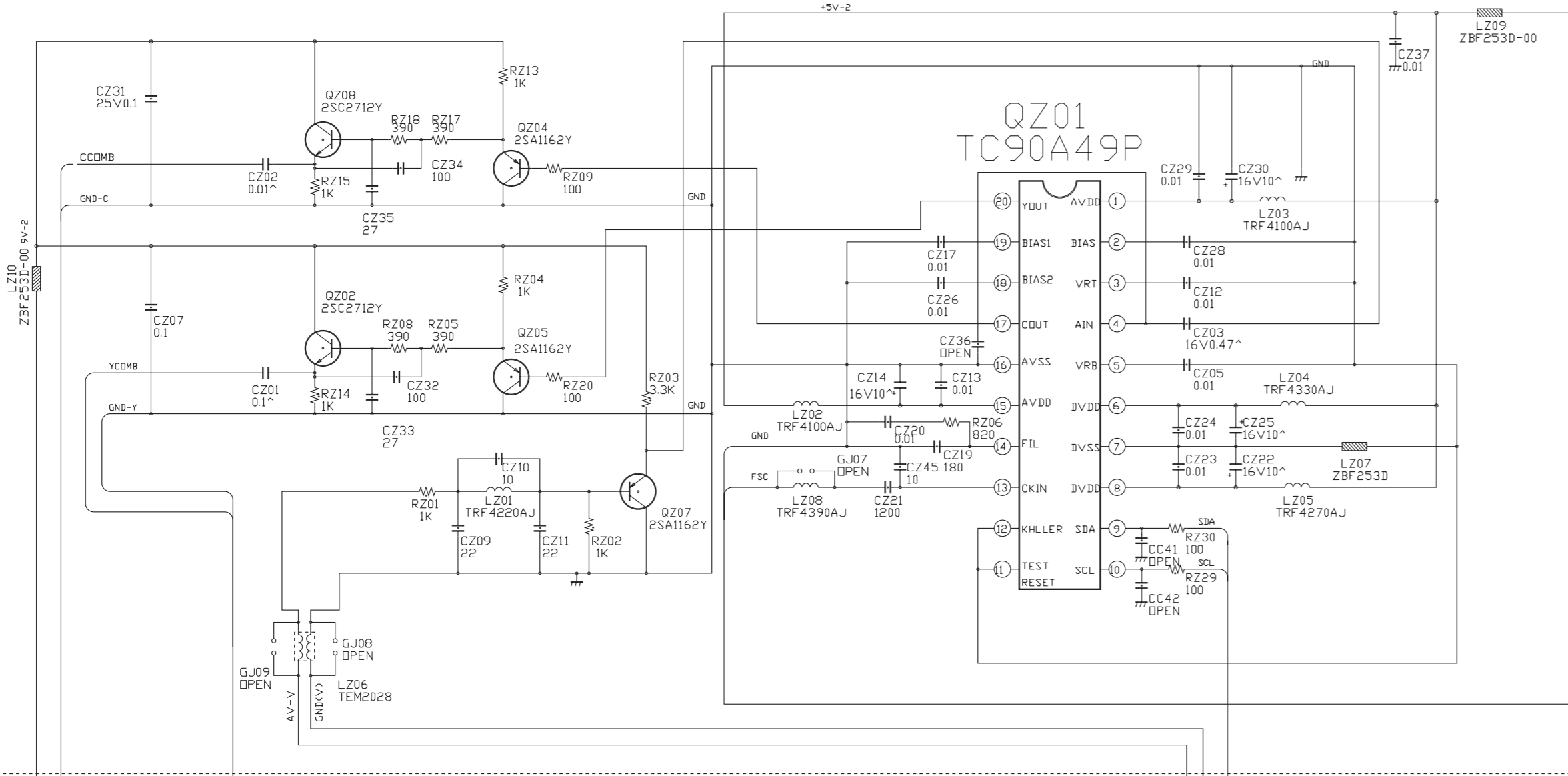

Q501  
TB1239BF  
MULTI COLOUR  
DECODER

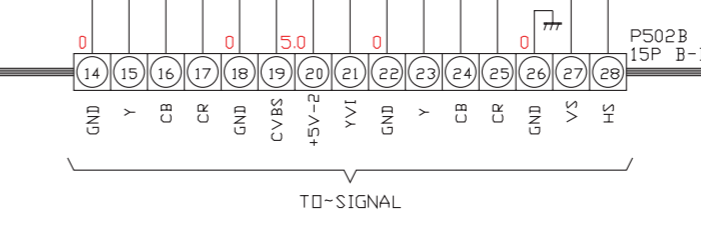
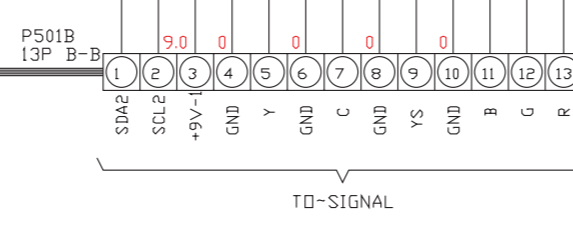
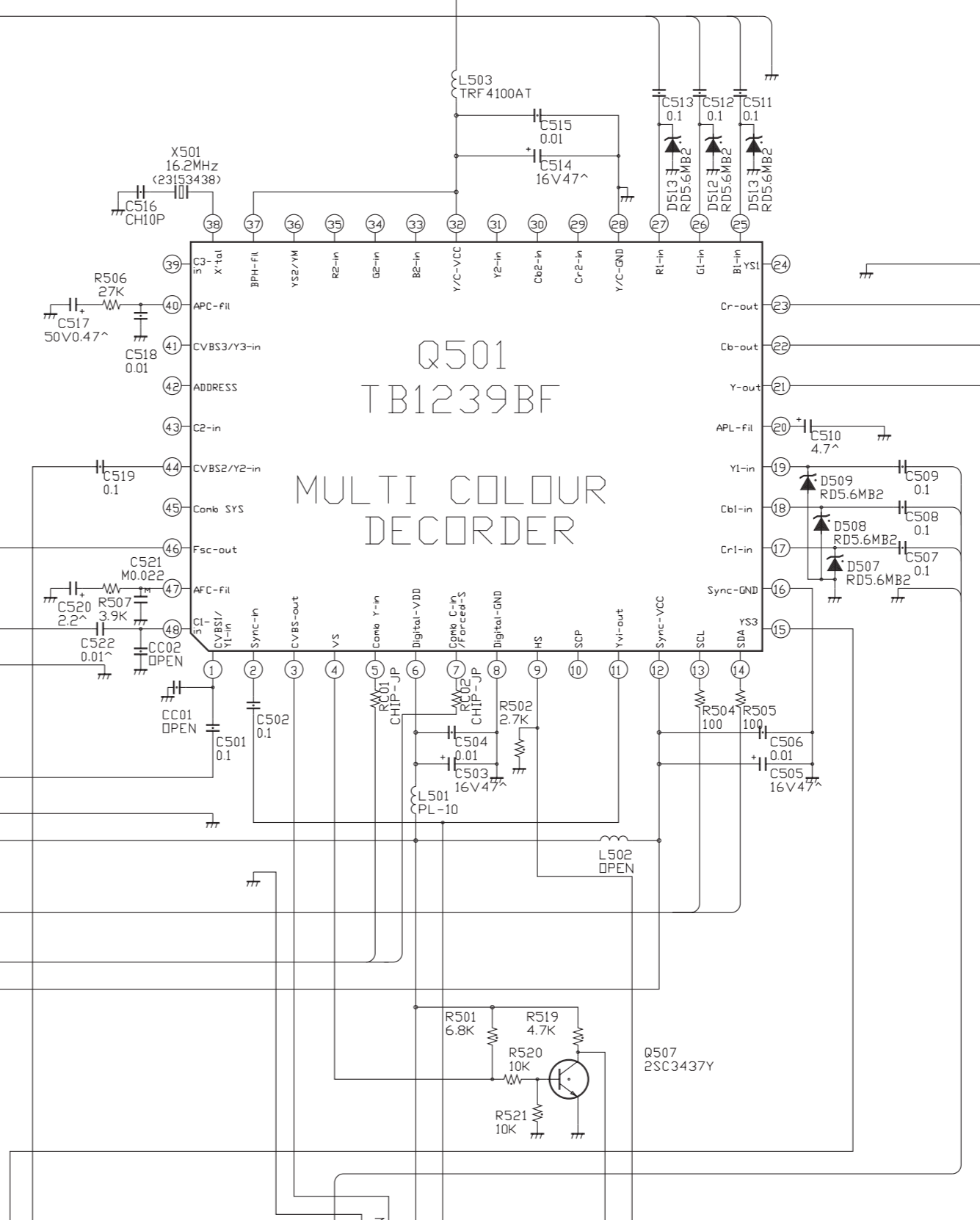

UNIT SN.		COPPER SIDE PARTS	
MCD	SN.23784878	SN.	
	SN.	SN.	
	SN.	SN.	
	SN.	SN.	

1

2

3

A

B

C

D

# U103 D-COMB&MCD BOARD PB 9

## DIGITAL-COMB-FILTER

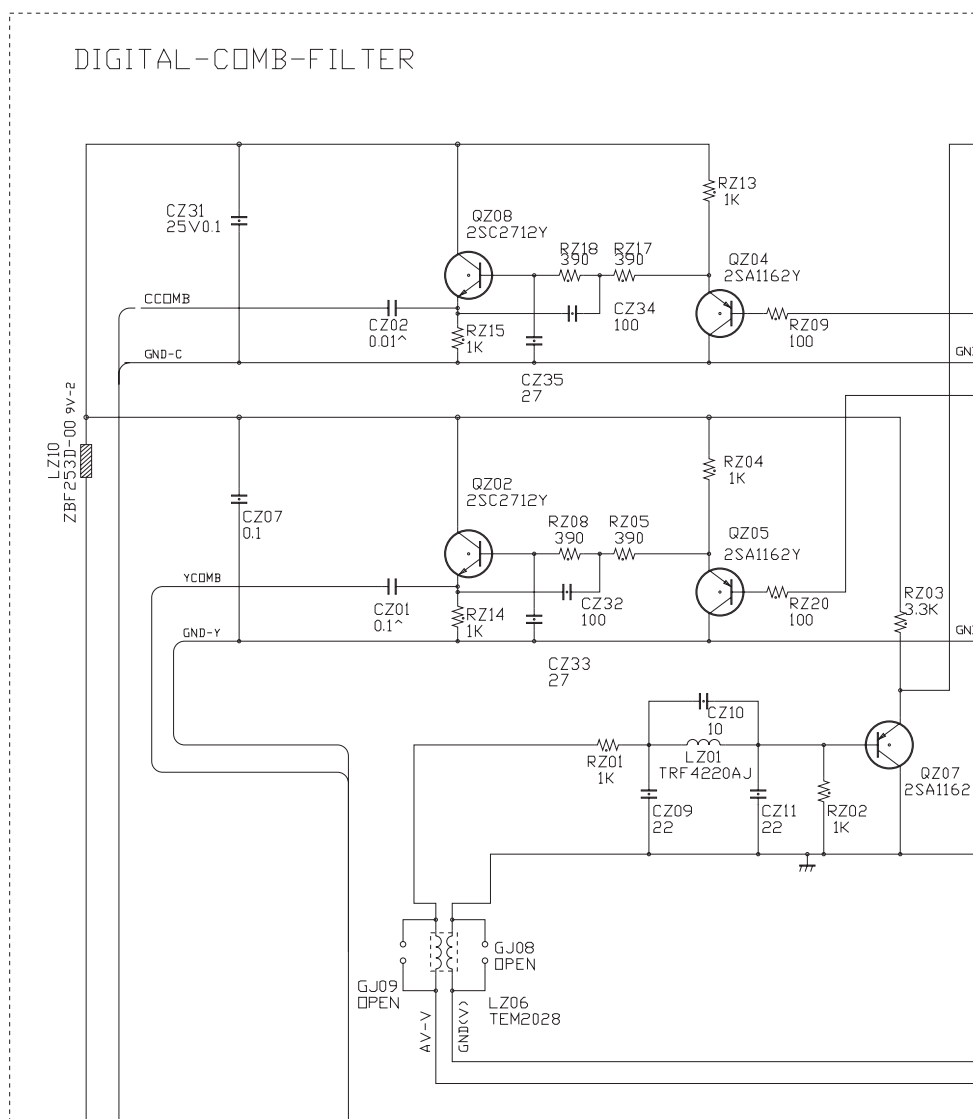

9510A

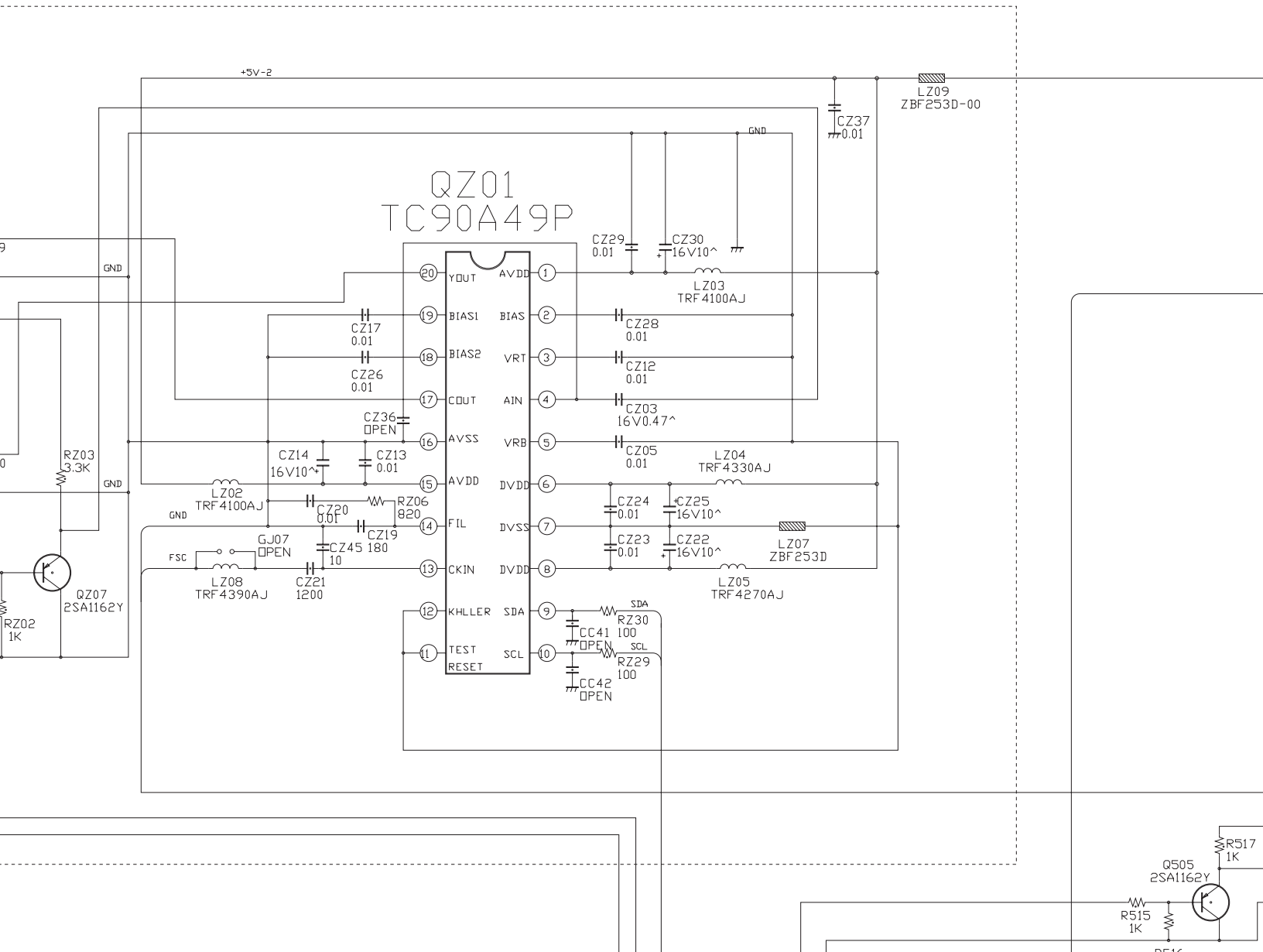

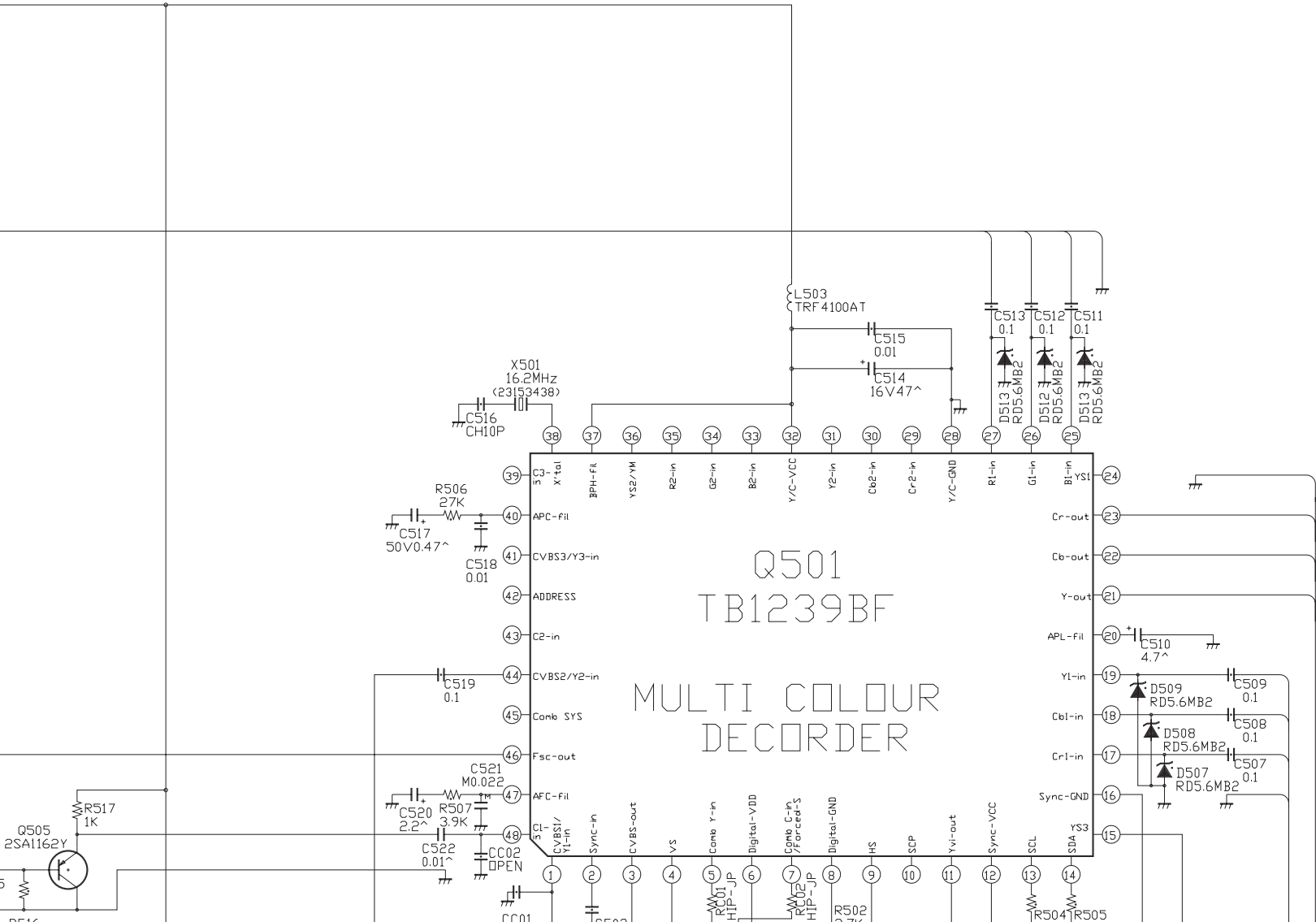

10

11

12

A

B

C

D

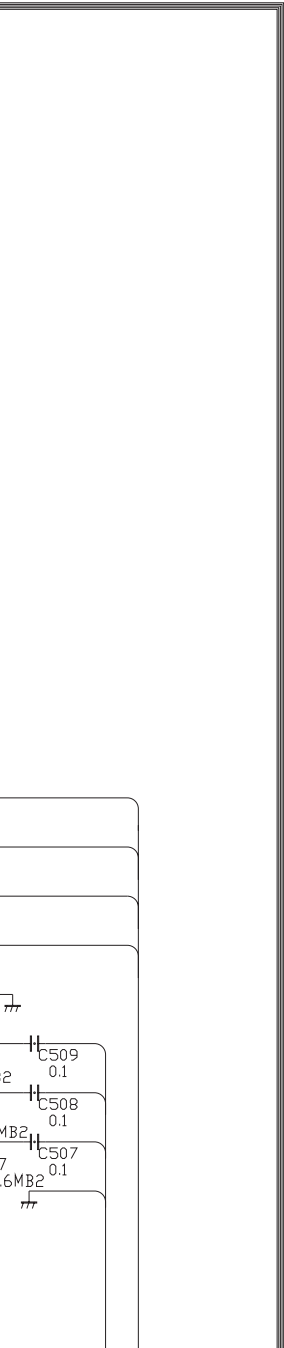



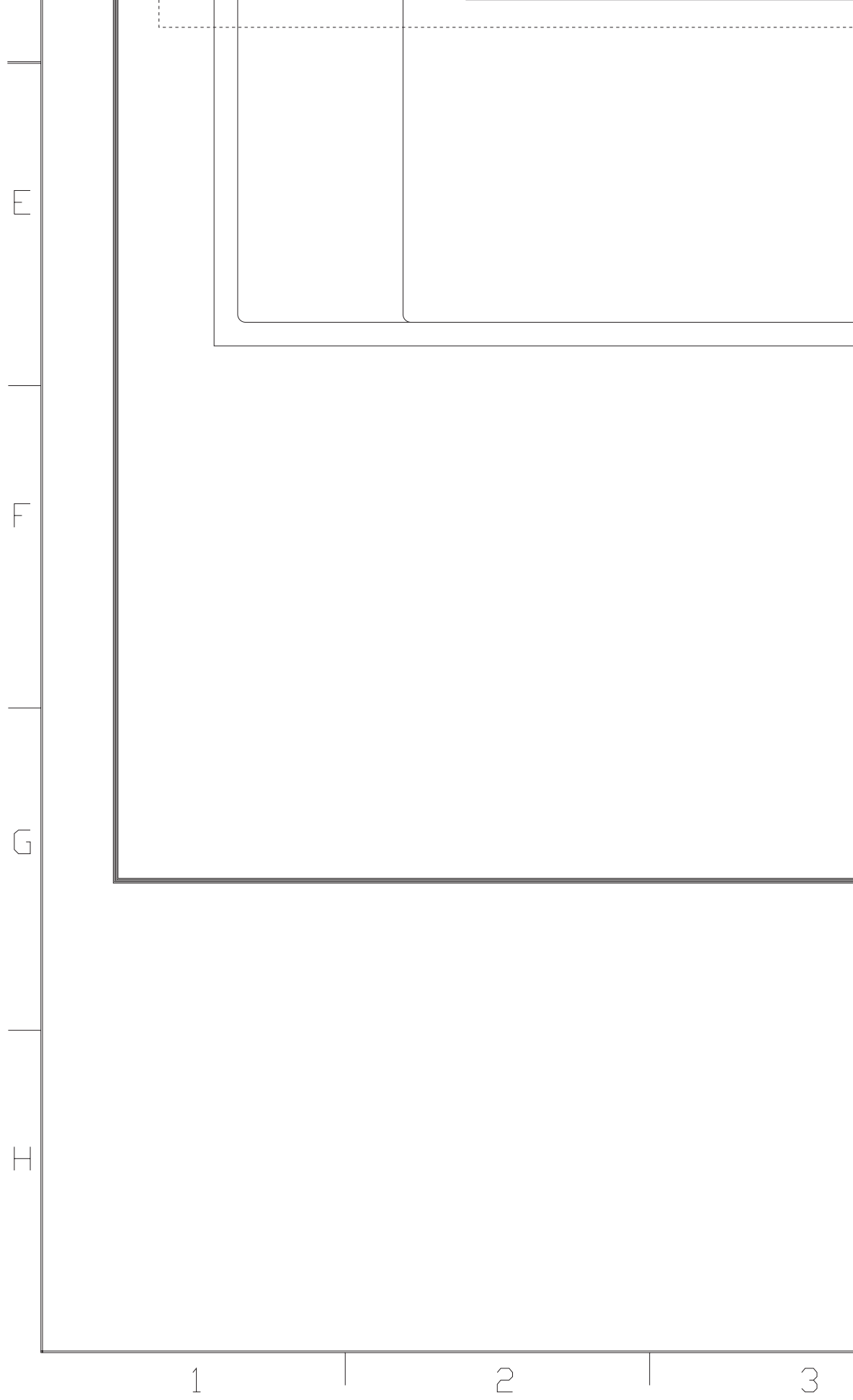

P501B  
13P B-B

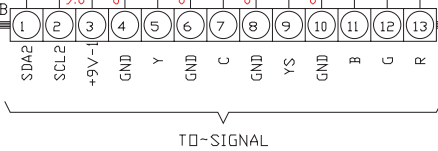

SCL&SDA

+9V-2

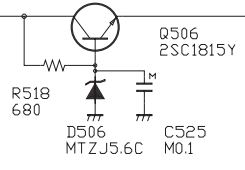
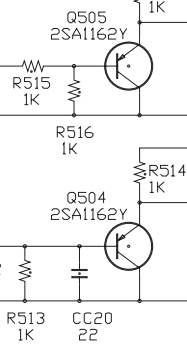

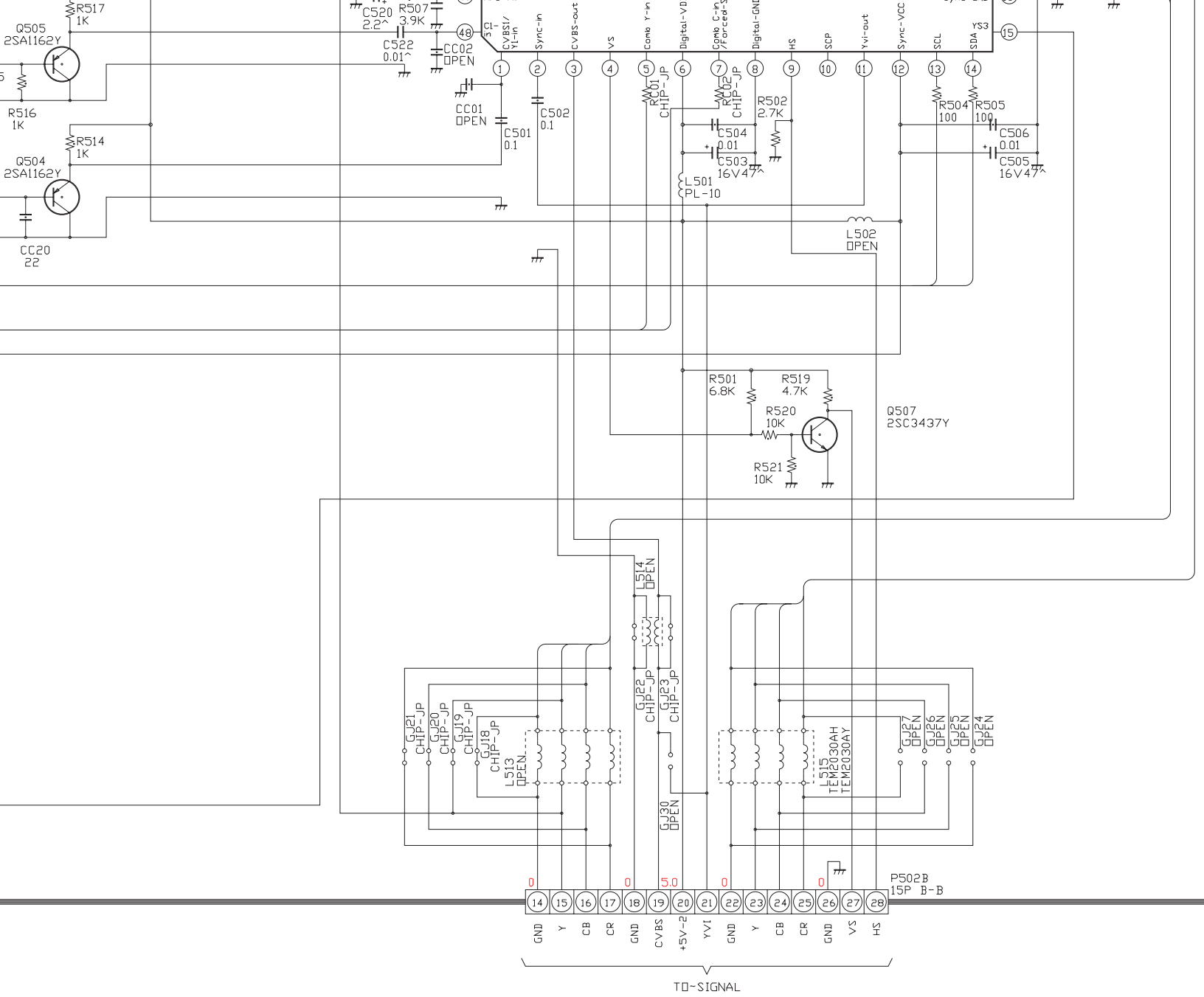

UNIT SN	
MCD	SN.23784878
	SN.
	SN.
	SN.

COPPER SIDE PARTS	
	SN.
	SN.
	SN.
	SN.
	SN.

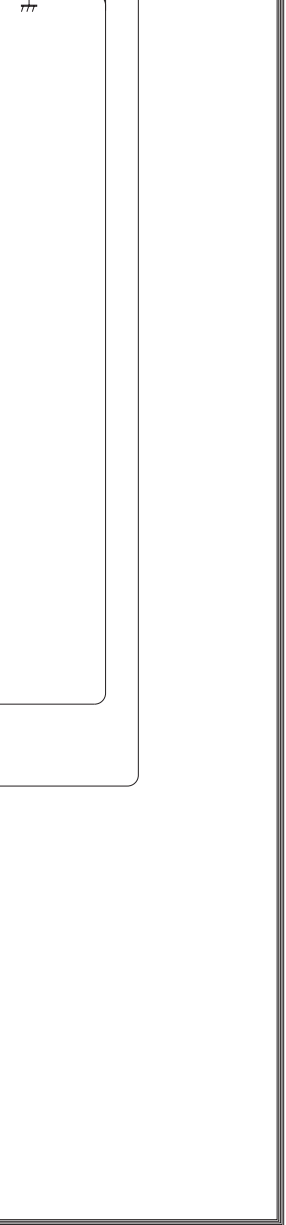

E

F

G

H

D-COMB&MCD PART  
32ZD08G 6/7

10

11

12

U104AEPG-TEXT(V)P2511A

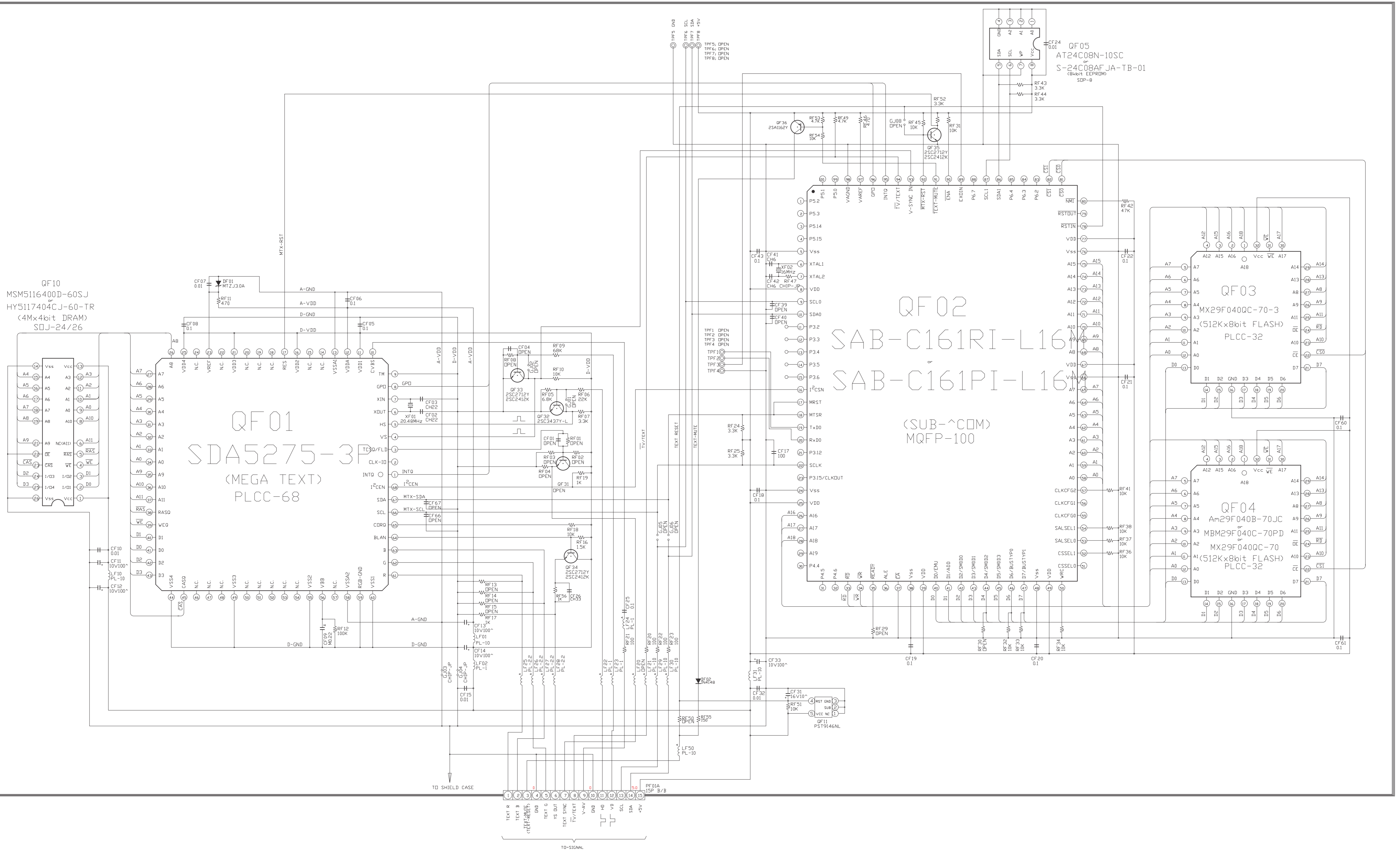

UNIT SN		COPPER SIDE PARTS	
EPG	SN 23784879	SN	
	SN	SN	
	SN	SN	
	SN	SN	

1

2

3

A

U104AEPG-TEXT<Ver>PB2511A

B

C

D

QF10  
 MSM5116400D-60SJ  
 or  
 HY5117404CJ-60-TR  
 (4Mx4bit DRAM)  
 SOJ-24/26

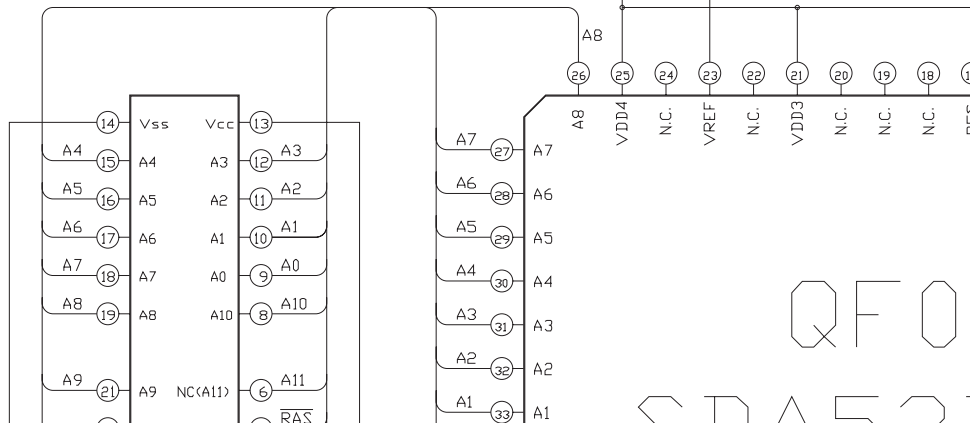
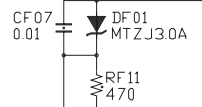

MTX-RST

3

4

5

6

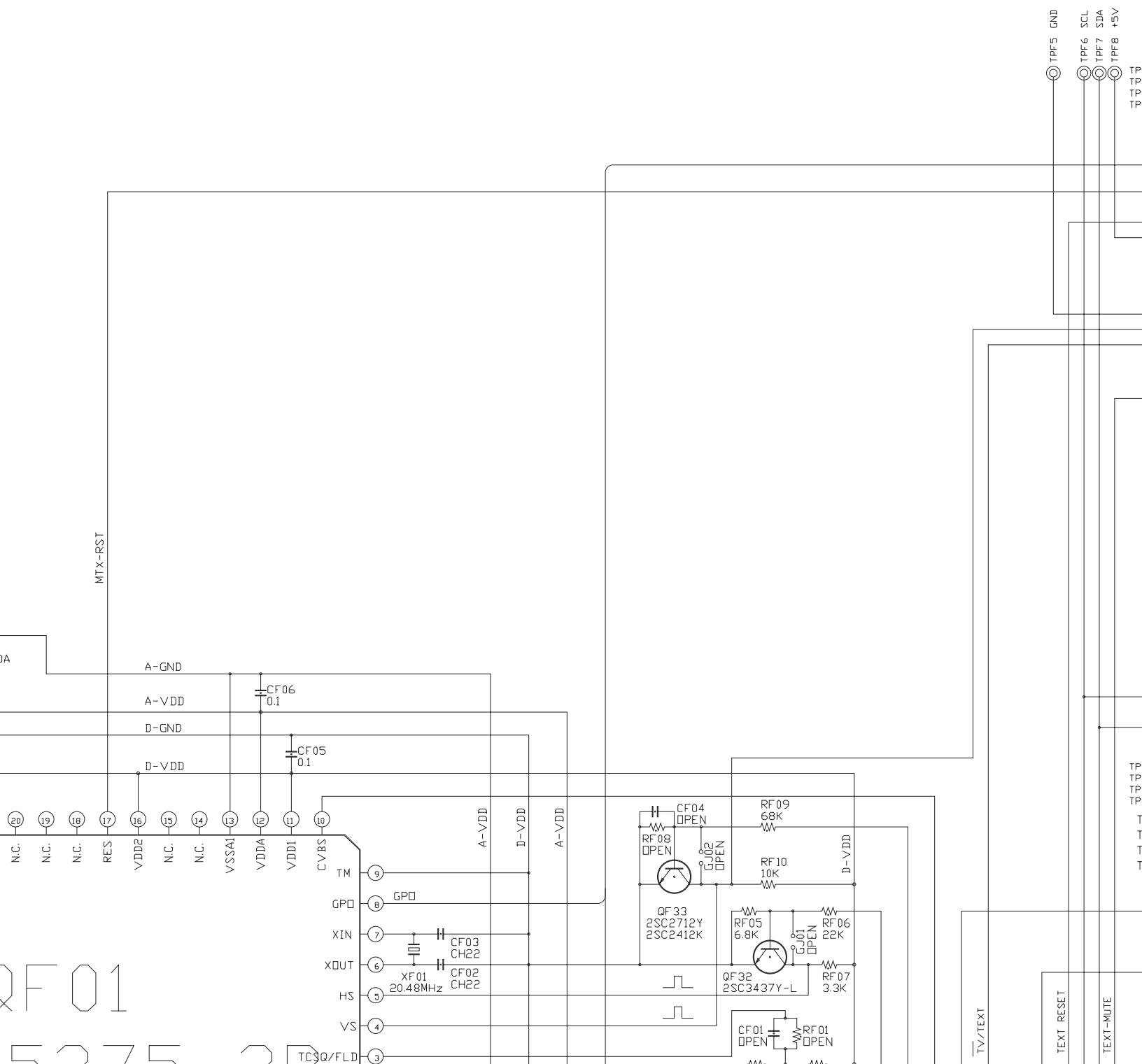

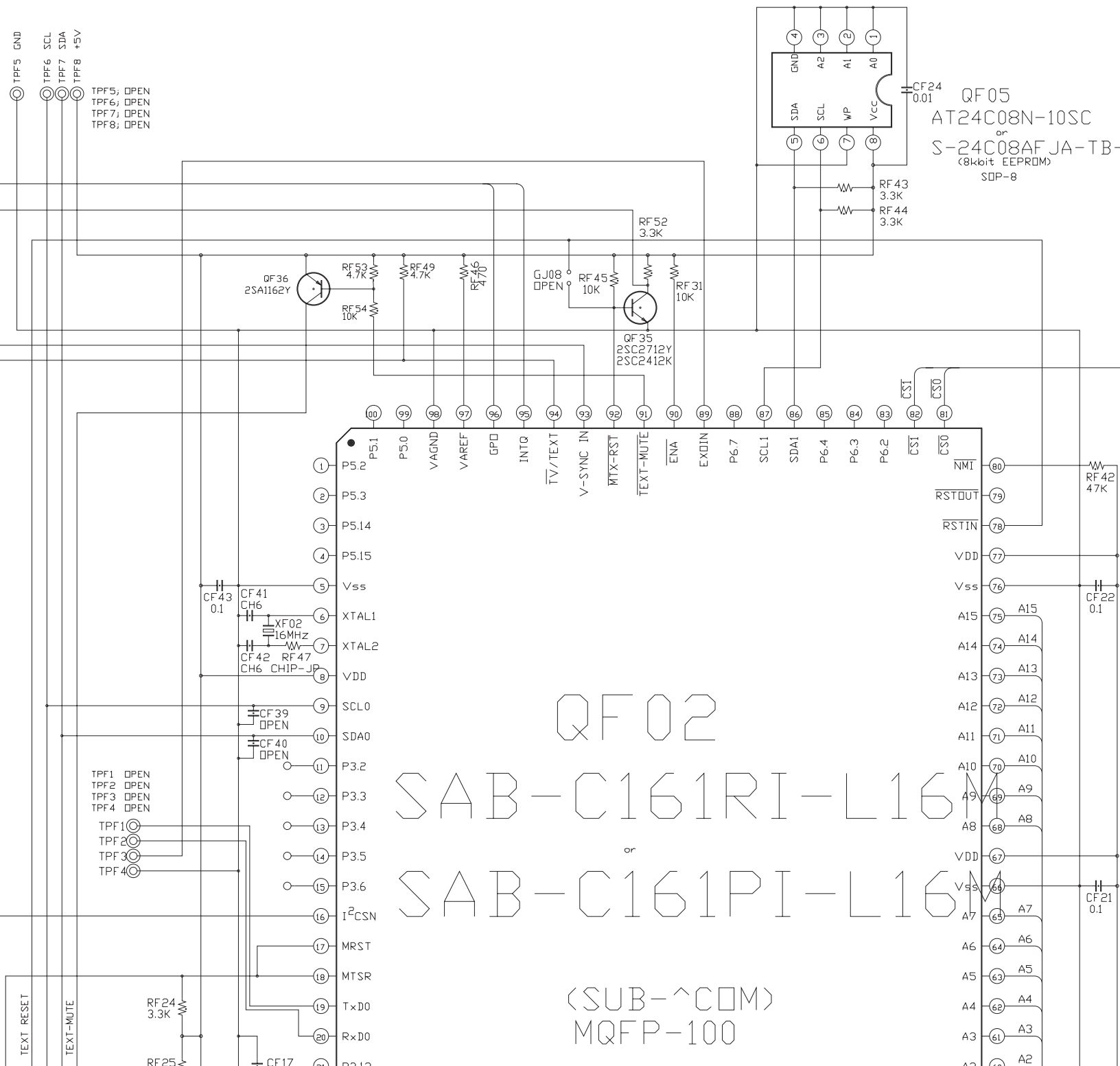



10

11

12

A

B

C

D

3N-10SC  
3AF JA-TB-01  
PROM

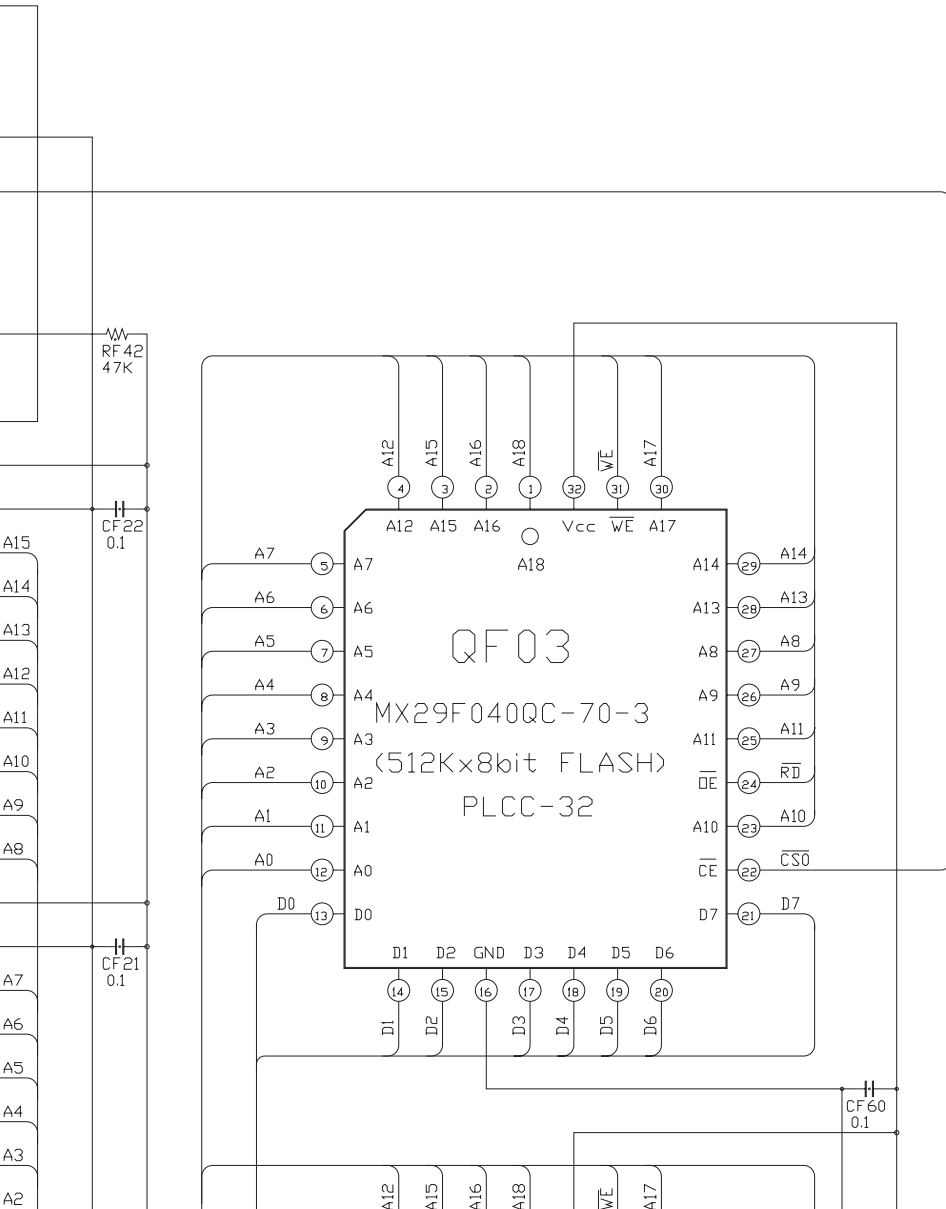

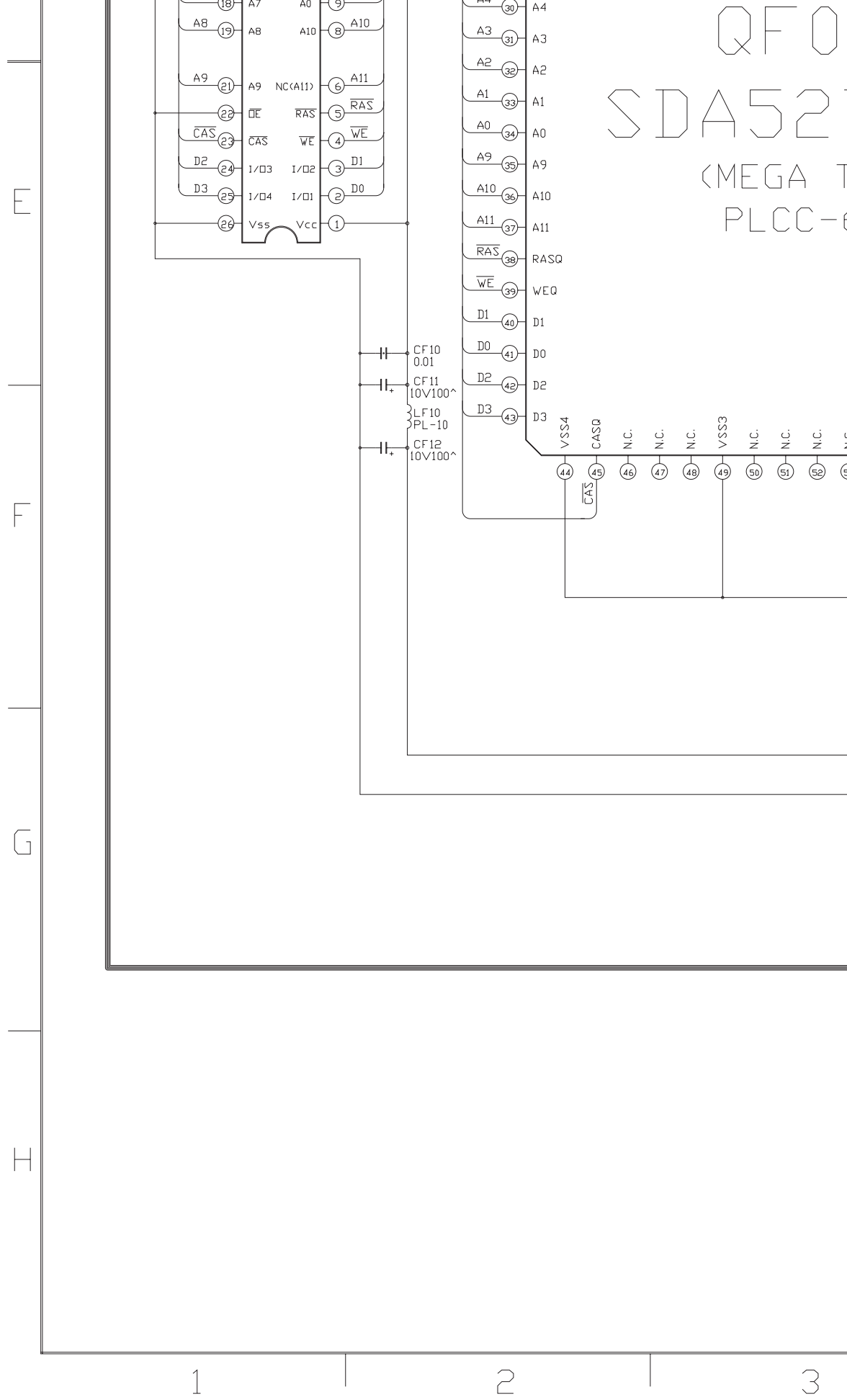

QF0

SDA52

(MEGA T

PLCC-6

XF 01

5275-3

EGA TEXT)

PLCC-68

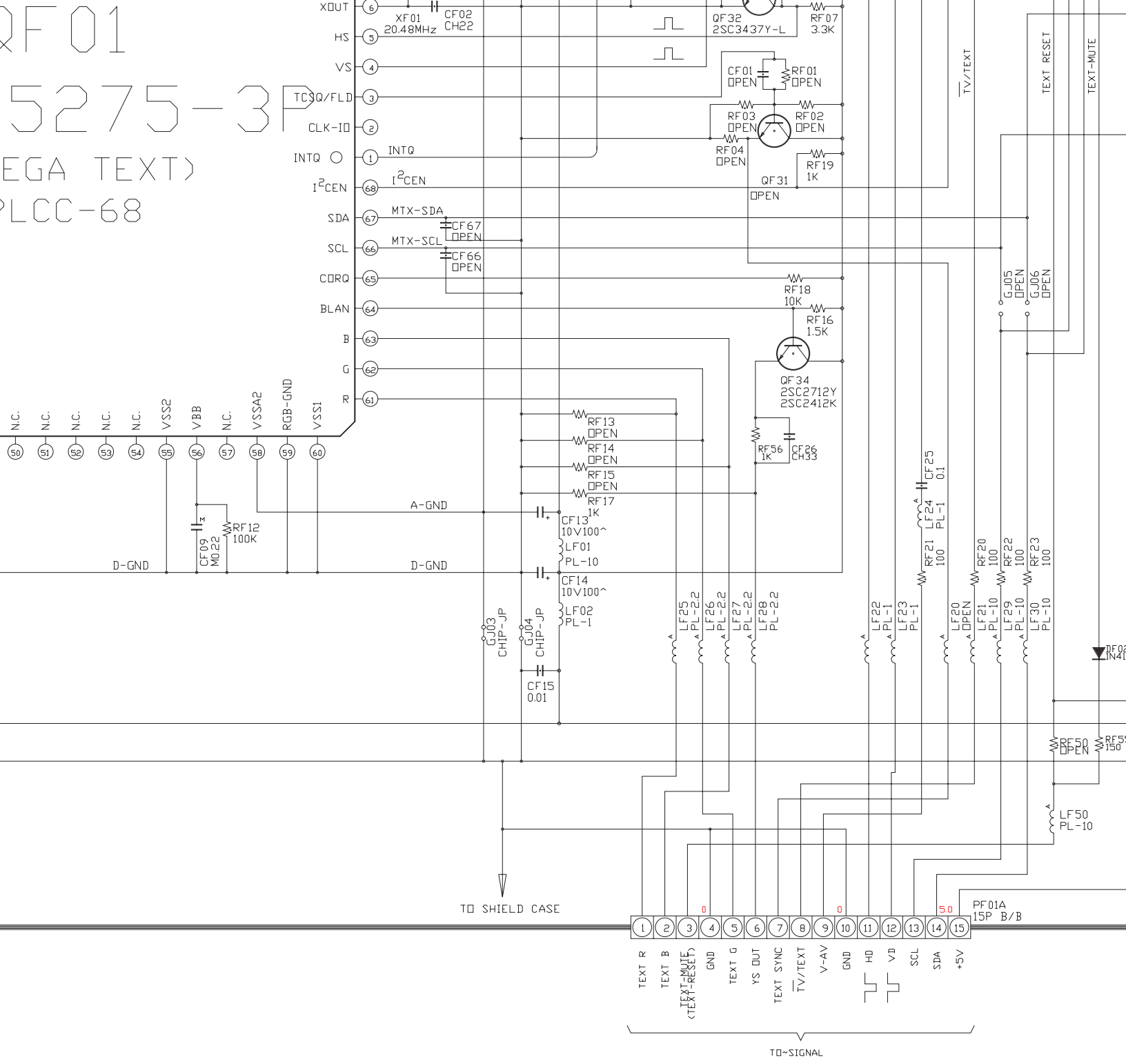

TO SHIELD CASE

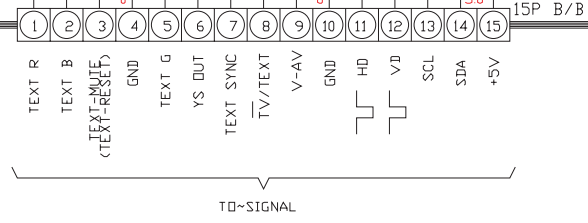

3

4

5

6

(SUB-^COM)  
MQFP-100

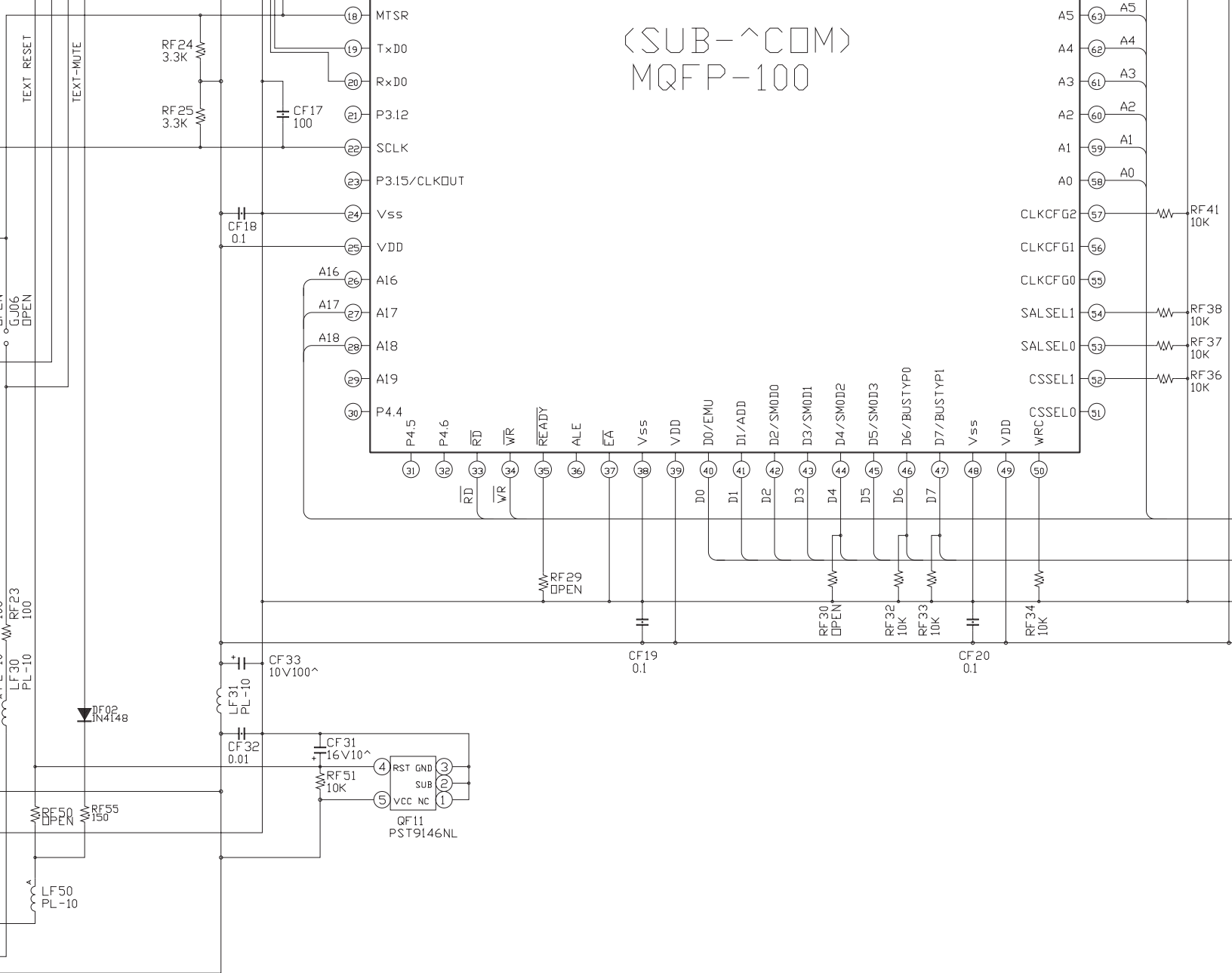

UNIT SN.	
EPG	SN 23784879
	SN.
	SN.
	SN.

COPPER SIDE PARTS	
	SN.
	SN.
	SN.
	SN.
	SN.

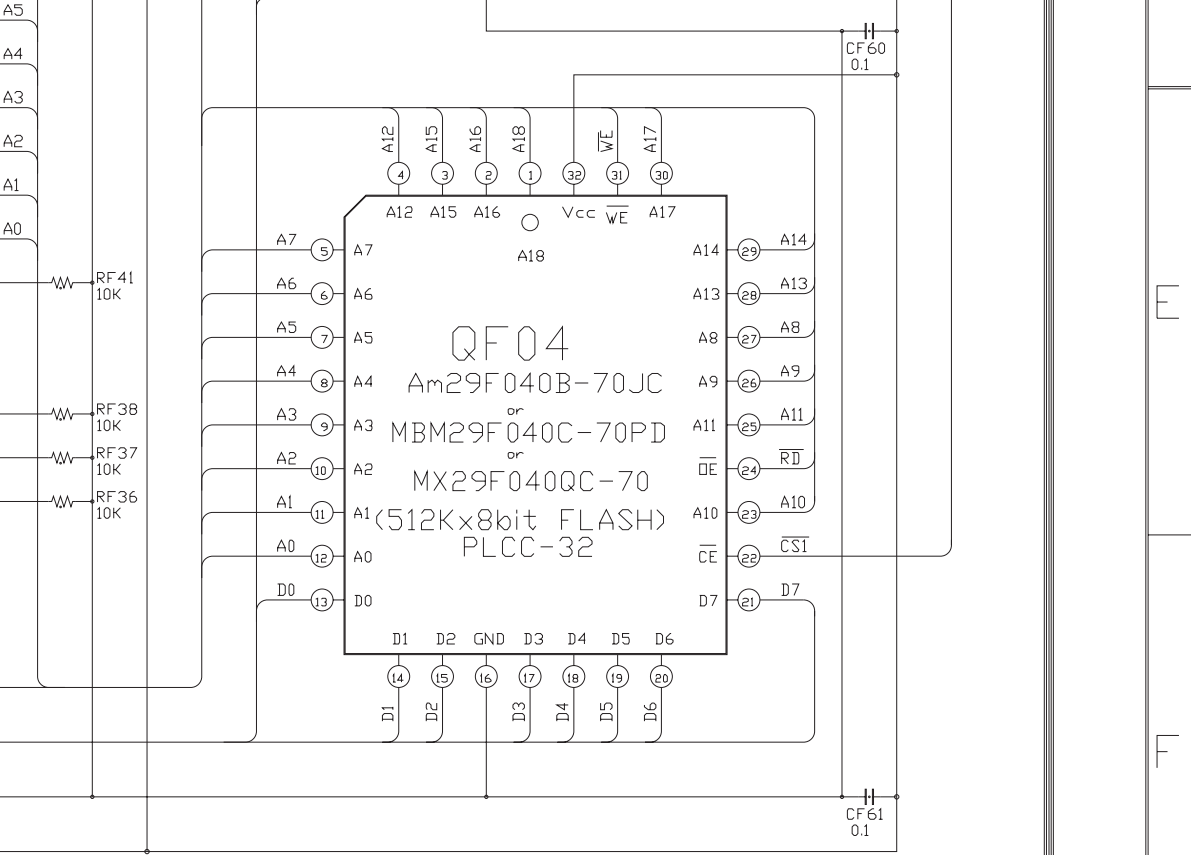

E

F

G

H

EPG-TEXT(Ver.2)  
 32ZD08G7/7

10

11

12